

# SYSTEM Q

## PROGRAMMABLE LOGIC CONTROLLERS

**One platform –  
many solutions**



**PLC Control /// Motion /// PC /// Process /// Multi CPU solutions ///**  
**Redundancy /// IEC 61131-3 /// Networking /// Scalable ///**  
**Machine control /// Plant management ///**

# Global Standards



Through Mitsubishi Electric's vision, "Changes for the better" are possible for a brighter future



Mitsubishi Electric Corporation Nagoya Works is a factor certified for ISO14001 (standards for environmental management systems) and ISO9001 (standards for quality assurance management systems)



## Flexible automation

System Q provides total global solutions for a vast range of applications. Pioneered by Mitsubishi, System Q is a single automation platform that brings together modular control features from a variety of different engineering disciplines, including traditional and advanced programmable logic controllers (PLCs), information technology, motion and process-based control philosophies. Because the focus is on boosting productivity, the System Q automation platform helps users reduce the total cost of ownership while increasing their return on investment

## Manufactured to the highest standards

Mitsubishi automation products enjoy a global reputation for outstanding quality and reliability. The process starts at the design stage, where quality is designed into even the smallest components. Our systematic pursuit of "best practice" means that Mitsubishi products readily comply with shipping approvals, product directives and standards.

## One of the world's top PLC makers

The 2004 Worldwide PLC Survey conducted by the respected American automation research company ARC confirmed that Mitsubishi Electric is the world's largest volume producer of PLCs.

# Contents

<b>Range overview</b>	<b>4</b>	
<b>PLC control</b>	<b>6</b>	
<b>Motion control</b>	<b>8</b>	
<b>Process control</b>	<b>10</b>	
<b>PC control</b>	<b>12</b>	
<b>Safety for all systems</b>	<b>14</b>	
<b>Programming</b>	<b>15</b>	
<b>Plant solutions</b>	<b>16</b>	
<b>Machine solutions</b>	<b>17</b>	
<b>Applications</b>	<b>18</b>	
<b>Section 2: Technical Informations</b>		

# What makes a world beating



## Global use

A wide range power supply means your Modular System Q will work all over the world and with the huge range of shipping approvals, CE compliance, as well as manufacturing to Automotive industry quality levels, SystemQ is a product to trust.



## Totally scalable

System Q is designed to grow with your application, from the Q00UJ standalone solution to the networked and redundant process CPU Q25PRH. System Q's platform concept allows you to add and customize the special functions you need.



## Multi CPU

The SystemQ Automation Platform allows you to use multiple CPU's on a single backplane. You can combine up to four CPU types, such as PLC, Motion, PC, C-CPU and Process CPU's, as well as NC and Robots CPU's, as a single seamless solution.



Single or redundant power supplies (AC and DC)

Programming via USB, Serial, Networks (CC-Link IE, CC-Link, Ethernet)

Task sharing with multiple CPU's, (up to four different CPU's in a single system)



# Modular Controller?



Easy maintenance with bright LEDs indicating the operational status

All CPU's support the same range of I/O and special function modules



## Multi network connectivity

From basic AS-Interface to Ethernet based networks, System Q can communicate easily with Mitsubishi or third party products. To increase the productivity in your plant, System Q can also provide a direct connection to any database based on SQL via an Ethernet connection.



## Flexibility

The wide range of power supplies, CPU's, I/O Modules, Special Modules and Communication Modules makes System Q one of the most flexible modular automation systems in the world.



## Dual redundancy

The redundant Process CPUs Q12/25PRH can, with standard PLC technology, provide a hot standby system with the automatic synchronization of data. The modular concept also allows different degrees of redundancy from power supply and control systems to redundant network modules.

# Sophisticated yet simple

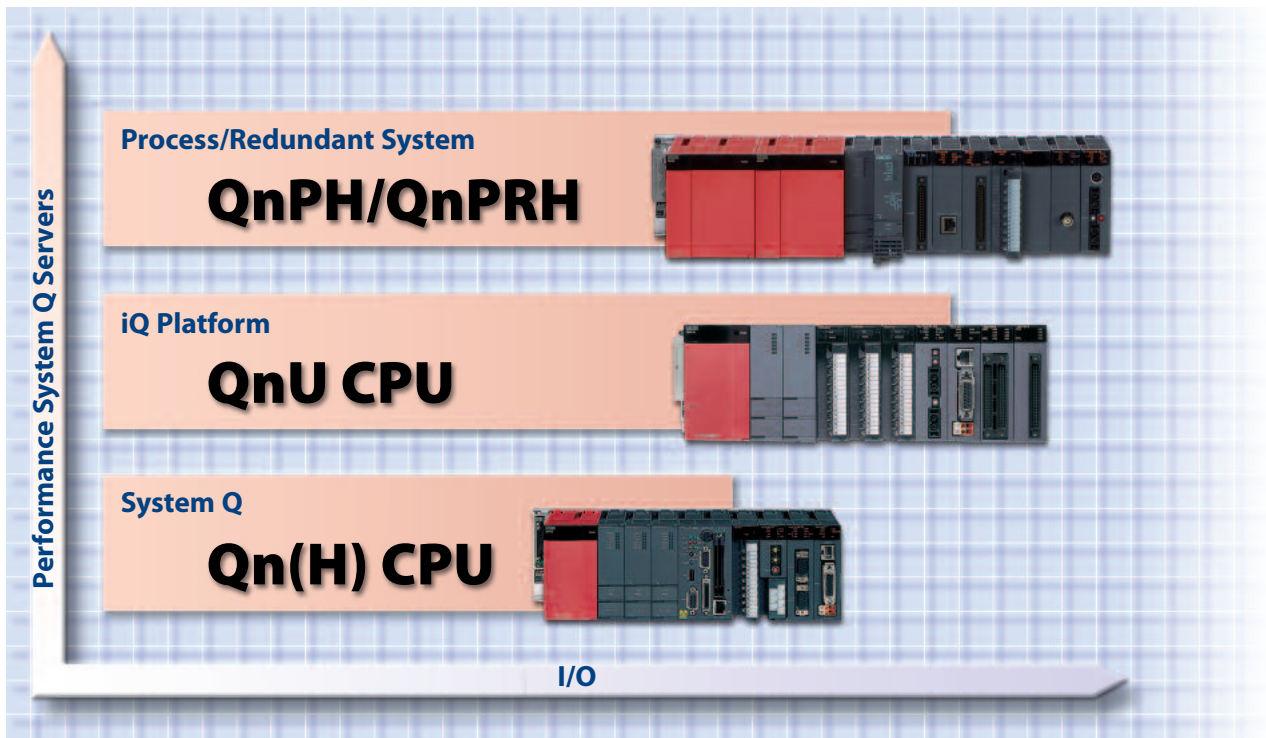

Mitsubishi Electric's modular control solutions span a wide range of capabilities.

## The modular concept

This concept allows users to mix and select the best combination of CPUs, communication devices, specialist control modules and discreet I/O on a back-plane. This allows users to configure systems into what they need, when they need it, where they need it.

## Multiple capabilities

Basic and advanced PLC CPUs, specialist motion and process controllers and even PCs can be combined into a single SystemQ solution with up to four different CPUs. This gives users a choice of control philosophies, programming concepts and programming languages – all from a single platform.

## An automation platform for the future

Flexibility and scalability are key design features that enable System Q to truly be a single Automation Platform. Users can apply simple control to an individual machine or integrated plant wide management all from the same hardware base.

Supporting the System Q platform is a suite of software tools enabling easy and comprehensive integration through EZSocket, Mitsubishi's own middleware. In addition, Mitsubishi also offer software tools that comply with international standards such as IEC1131.3, OPC and Active X. This tremendous flexibility permits users to reduce development time, simplify commissioning, and provide ongoing system maintenance.

# Modular control

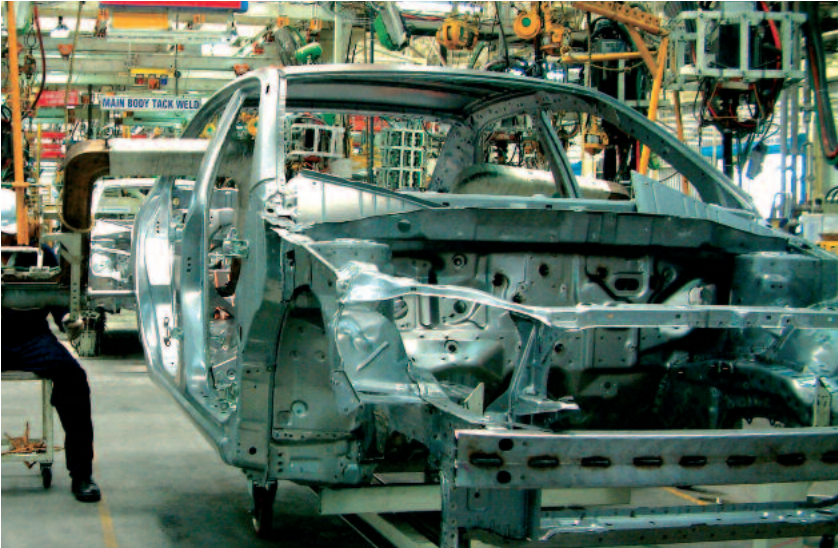

Reliable control when you need it most.

## Basic PLCs

Not every control application requires the full power of System Q. For example, many machine builders embed control technology into their machines and require small compact designs featuring flexible high-speed operation. System Q's Basic PLC CPUs offer just this kind of solution, balancing power and performance against cost. A good example of this is the Q00J CPU.

This all-in-one unit provides power supply, CPU and backplane as a single, ready-to-use unit ideal for small systems that still require powerful performance.

Other Basic PLC CPU options include the classic modular designs Q00 and Q01, the first steps on the path to the full System Q automation platform.

## Advanced PLCs

For advanced machine designs and controlling manufacturing cells, including infrastructure and site-wide management, System Q's advanced PLC CPUs offer incredible performance and versatility.

Processors are available with a wide range of memory capacities, all of which can be expanded as required. This means that System Q PLCs can support complex programs as well as store large volumes of operation data.

## Universal PLC CPUs

These universal PLC CPUs are the latest generation of modular CPUs for the MELSEC System Q controller platform and they are the foundation of the iQ Platform system. They can be combined with the motion, robot and NC CPUs to configure scalable and highly flexible modular automation systems.

## Scalable

With the exception of the embedded Q00J CPU, all System Q PLC processors are interchangeable, which means processing power can be increased as applications grow, protecting your investment in infrastructure and hardware.



Multi CPUs can make light work of complex tasks

## Multi Processor support

Up to four separate System Q PLC CPUs can be placed in a single system. These can be used to control their own set of dedicated tasks or for sharing the processing and control load, making the total system highly responsive. This provides users with faster, more dynamic control, leading to better production quality and improved production rates.

## Robots and NC CPUs

Robots and CNC controllers combine faster processing speed and enhanced motion control, providing superior flexibility and performance when designing Motion and Robot automation systems.

PLC CPU overview					
CPU type	Basic PLC	Advanced PLC	Universal PLC	Robot CPU	NC CPU
Model range	Q00J-Q01	Q02-Q25H	Q00UJ-Q02U Q03UD(E)-Q26UD(E)H	Q172DCCPU	Q173NCCPU
Total inputs/outputs	256-1024/2048	4096/8192	256-4096/8192	32-256	4096/8192
Memory capacity	58-94 kB	32 MB	32 MB	2 MB	*
Program memory	8-14 k steps	28-252 k steps	10-260 k steps	26 k steps	260 k steps
Program cycle period per logical instruction	0.20-0.1 μs	79-34 ns	9.5-120 ns	*	*
Multi CPU capability (Max. 4 CPUs)	Yes on Q00CPU and Q01CPU	Yes - up to 4 per system	Yes - up to 4 per system	Yes - up to 3 per system	Yes - up to 2 CPU

\*Please check dedicated manuals



# Power in motion



High speed and high levels of control and reliability. System Q's automation platform can deliver even in the most demanding applications.

To control these servo systems as well as those made by other manufacturers, System Q offers solutions ranging from individual motion/positioning cards to advanced motion CPUs capable of synchronised operation across many axes.

## In control

System Q's unique design allows users to select and use different combinations of CPUs from the same platform. For example, motion CPUs can be employed independently or in tandem with PLC, PC or process CPUs.

Thanks to the dedicated motion control network SSCNET III, each motion CPU can connect up to 32 servo axes. In addition, three motion CPUs can be used in a single System Q solution to bring advanced motion control to 96 axes.

## The Challenge

Modern manufacturers insist on fast, reliable production. This means that machine builders have to find ever-more creative ways of increasing machine performance, reducing commissioning times, and minimizing maintenance. Not an easy task.

One way of achieving these goals is the increased use of servo and motion technology. Mitsubishi Electric leads the way here with innovative servo drives featuring advanced auto tuning, meaning that they practically configure themselves.



System Q brings machine control and motion into harmony.

Motion CPU overview		
CPU Type	Motion Controller	
Model	Q172DCPU	Q173DCPU
Control axes options	8	32 (up to 96 axes when 3 CPUs are used in one system)
Total Inputs/Outputs	4096/8192	
Number of positioning data items	3200 positioning points	
Program memory	14 kB PLC program, 543 kB total servo positioning program	
Processor speed /cycle time	0.4 ms cycle time (SV13)	
Multi CPU capability	Yes – up to 3 Motion CPUs per 4 CPU system	

For users who do not need a full motion controller, System Q offers over 12 individual control cards. Each type of special function card is available in a range of 1, 2, 4 or 8 control axes; control methods include open collector and differential output, as well, of course, as the SSCNetIII. Also available are standard, general purpose, pulse train output cards, and high-speed counter cards.



Flexible control options from a single platform.

Given this wide range of motion CPUs and dedicated control cards, it is easy to see how System Q can be customized to work with almost any servo manufacturer's products, as well as being totally optimized for use with Mitsubishi Electric's own advanced servo solutions.

## Networking: speed and reliability

SSCNet is a dedicated motion controller network developed by Mitsubishi Electric. It offers many advantages for fast, secure communications between up to 96 servo systems and their host controller.

The latest version is SSCNET III, a powerful third-generation product. It enables high-speed, full duplex, transfer rates of up to 50 MB/s as well as guaranteed network system cycle times of 0.44 ms. This extends to all 96 axes, making sure that user applications are really synchronised over all active servo drives.

## SSCNET

SERVO SYSTEM CONTROLLER NETWORK

The use of fibre-optic cabling is a great benefit to all users as it eliminates any concerns about stray electrical noise corrupting the high-speed communication process. This means SSCNET III users enjoy greater reliability and flexibility since the fibre-optic cables can be placed wherever they're needed – even alongside large electrical motors.



Servo and motion solutions are increasingly being used across many applications.

Positioning card overview								
Control method	Open collector			Differential output		Network		
						SSCNET III	SSCNET	
Model (* Is the number of axes)	QD75P*	QD70P*	QD72P3C3 ①	QD75D*	QD70D*	QD75M*	QD74MH*	QD75MH*
Control axes options	1, 2, and 4	4 and 8	3	1, 2 and 4	4 and 8	1, 2 and 4	8 and 16	1, 2 and 4
Control units	mm, inch, pulse and degree	pulse	pulse	mm, inch, pulse and degree	pulse	mm, inch, pulse and degree	pulse	mm, inch, pulse and degree
Number of positioning data items	600 data items/axes	10 data items/axes	1 data item/axe	600 data items/axes	10 data items/axes	600 data items/axes	32 data items/axes	600 data items/axes

① with build-in counter function



# Process control you can count on



Reliable system operation is essential in the process industry.

## A platform to build on

The strength of System Q's automation platform really comes into its own in traditional specialist industries. The unique flexibility of proven off-the-shelf control components such as I/O and communication devices, teamed with dedicated special devices like process CPUs, assures high functionality, ease of use and targeted control – all within budget.

## Two worlds meet

Our dedicated SystemQ process CPUs build on the already high functionality of Mitsubishi's advanced PLC CPUs. This powerful combination of sequential control overlaid with dedicated process instructions gives users a hybrid control solution with the best of both worlds.

This is complemented in turn by a range of dedicated channel-isolated and high-resolution analogue modules. Here, too, a combination of specialized and standard modules as well as HART protocol supporting analog I/O's provide the basis for practical and flexible solutions.

High system availability can be maintained through various means, including redundant process CPUs, stand-by network masters, and redundant network configurations, as well as by wire-break detection and a "hot-swap" capability that allows modules to be replaced during live operation.

Programming can be implemented using a wide range of tools such as IEC 61131-3 compliant software and the process-dedicated PX Developer.

## Process CPUs

System Q's Process CPUs bring the benefits of standard System Q technology into the process environment, reducing both implementation and long-term running costs. These powerful processors combine standard PLC control with 52 dedicated process control functions, including loop controls with two degrees of freedom (DOF) and high-speed PID control.



Complex processes involving liquids, pressures, temperatures can often need fast PID control algorithms.



The high availability of the dual redundant System Q can be applied to a wide range of industries from Food and Utilities to Process, and Chemical.

## High reliability systems

The System Q automation platform can also be applied to other areas requiring high reliability, e.g. standby network masters, redundant fieldbus (CC-Link) and redundant power supplies for remote I/O stations.

## Redundant CPUs

Mitsubishi Electric's dual-redundant CPUs bring an additional layer of fault tolerance to the control of a whole system. This results in high reliability: if the main CPU, power supply or base unit fails, a secondary system starts immediately (within 21 ms) from the same control point.

In addition, selected analogue and temperature control units have a wire-break detection feature enabling them to determine the difference between an actual signal and one that has been lost due to external system damage.

For users this has two major benefits: no operational damage due to a single system failure, and production that continues seamlessly.

Overview of Process CPUs						
CPU Type	Process CPU				Redundant CPU	
Model	Q02PHCPU	Q06PHCPU	Q12PHCPU	Q25PHCPU	Q12PRHCPU	Q25PRHCPU
Total Inputs/Outputs	4096/8192					
Memory Capacity	32 MB					
Program memory	28 k steps	60 k steps	124 k steps	252 k steps	124 k steps	252 k steps
Program cycle period per logical instruction	34 ns					
Multi CPU capability (Max. 4 CPUs)	Yes – up to 4 per system				No	

# IT for support, monitoring and control



Integrated, embedded or networked – IT is the link from the operational environment to the management function.

Information technology has emerged as the prime conduit linking the operational site to the management function. Not only can production data, schedules and quality information be shared; maintenance and operations can be activated over the same structures.

## Industrial strength IT

System Q is unique in being able to embed a fully equipped Windows® PC into a robust industrial design directly at the heart of the control system. The potential uses and benefits are enormous: users are completely free to write their own control and directly actuate I/O control.

Alternatively, it can be used as an embedded monitoring point, running a SCADA installation or user-created VB applications.

With a fanless design concept, the unit is designed to have as few moving parts as possible, as these are often the points of operational failure. In fact, this principle extends to the optional silicon hard drive, which has no moving parts at all, making Mitsubishi Electric's System Q PC ideal for an industrial environment.



Flexible and secure PC technology can even be placed within an application.

This rack-based PC solution can be used as a stand-alone controller or in conjunction with any other System Q CPU to create a multidisciplinary automation platform.

## As easy as A, B, C

If System Q's automation platform is divided into A for PLC CPUs, and B for process CPUs, then C must surely stand for the industrial "C" controller. This advanced controller can be programmed in standard C or C++, opening up the world of automation and control directly to non-PLC based engineers. Furthermore, "C" programming is an ideal language for many process or complex math-based applications since it has a well-defined structured programming concept and flexible syntax.



System Q's C controller adds a whole new dimension to flexible control



The Q06CCPU module has been meticulously designed to eliminate as many failure-prone elements as possible, including fans and hard drives. Combined with the widely used Vx-Works operating system from Wind River, this makes Mitsubishi's C Controller a powerful CPU fit for industrial environments. In addition, programming support for the CoDeSys controller development system is available from 3S-Smart Software Solutions, which provides users with convenient object-oriented environments.

## Remote management

System Q offers various solutions to the problem of remote management. These can be used independently or combined into multifunction systems.

### ■ Networking

System Q supports over 50 different types of networking and communications modules, including Ethernet, MELSECNET/H, FL-NET, Profibus/DP, CC-Link, CANopen, DeviceNET, AS-interface, Modbus TCP, Modbus RTU and GP-IB. Thanks to System Q's single automation platform, communication is as easy as selecting the module you need.



Flexible and reliable communication is a key issue in many application regardless of scale and size.

### ■ Webservice

The QJ71WS96 is a dedicated webservice module that fits directly onto the System Q backplane. It offers on-board webpages as well as Java scripting and 100MB Ethernet that make it easier than ever to share information.



Web server technology brings intuitive access directly to the heart of the control solution.

### ■ Telemetry

Mitsubishi Electric offers two different modem solutions: basic and intelligent. Both types are available in tri-band GSM or PSTN formats and feature completely intuitive set-up software. This makes programming with Haynes control codes a thing of the past.

## MES Interface

With the QJ71MES96 module System Q users now have the possibility to connect directly with commercial database applications like Oracle, MS SQL Server and MS Access. The MES module supports bi-directional data transfer with several databases and the event-driven communications reduce the network load. The use of the MES module reduces system complexity and cost, making gateways a thing of the past.

## IPC panels

Information technology also comes to the System Q automation platform in the form of industrial personal computers (IPCs). These units provide an ideal solution for placing a PC access point directly in the production environment. Models can be connected directly to System Q or via a network, ensuring that all areas of the operation are kept supplied with up-to-date information directly from System Q.

Overview of System Q PC and C Controller CPUs			
CPU Type	PC	C Controller	C Controller
Model	PPC-CPU852(MS)-512	Q06CCPU	Q12DCCPU
Total Inputs/Outputs	4096/8192	4096/8192	4096/8192
Memory Capacity	Use of storage cards means data and programs can be stored for later retrieval	Use of storage cards means data and programs can be stored for later retrieval	Use of storage cards means data and programs can be stored for later retrieval
Program memory	512 MB (main) / 2 MB (cache)	32 MB (main) / 128 kB battery backed	128 MB (main) / 128 kB battery backed
Processor speed/cycle time	Intel Celeron M 600 MHz	SH RISC Processor *	SH RISC Processor *
Multi CPU capability (Max. 4 CPUs)	Yes - one per system	Yes	Yes

\* VxWorks real time system

# Safety for all systems



Keep plant personnel safe from harm

Mitsubishi Electric provides a total safety solution by incorporating safety control devices, safety drive devices, and safety components required for safety systems. This allows visualization information, realizing optimal safety control and boosting productivity.

## Flexible implementation

It's obvious that the safety solution has to protect workers from dangerous machinery and environments. However, from a cost perspective, it should also be simple to implement and flexible enough to meet the needs of any system design. System Q meets these requirements with a unique, multi-faceted safety solution. The safety functions can either be directly mounted on the rack, be decentralized I/O, or sit on the open CC-Link Safety network.

## Specify with confidence

The System Q safety solution has been fully certified by all applicable safety organizations to EN954-1 Category 4, ISO13849-1 PL e, and IEC61508 (JIS C 0508) SIL 3 and certified by TÜV Rheinland.

## Easy cost saving

The simplest System Q safety option is to fit a safety relay module on the rack alongside all other system components. In this way, a system which is mostly used for conventional control can also meet safety requirements without the need for the cost of a dedicated safety controller. The safety relay modules provide the right number of safety I/O without any special programming.

If safety I/O is required in other locations around the system, safety extension I/O modules offer additional "plug and play" safety by connecting directly to the safety I/O module on the rack.

System Q provides also the flexibility to add safety I/O modules to a conventional CC-Link network alongside other CC-Link devices such as inverters, I/O or HMI units.



## Small, simple, and safe

The MELSEC WS Safety Controller provides a cost effective way to add a safety controller capability to individual machines, or smaller scale systems. Its compact size insures easy placement in most control cabinets, without adding extra cost. Configuration saves engineering time by using a graphical icon based method, and program development and certification is simplified by the use of safety function blocks.

## Safeguarding large systems

The MELSEC QS Safety PLC offers a modern approach to safety by combining a CC-Link Safety distributed I/O network with the flexibility of a modular controller. This offers the capacity to cover an entire production line, while bringing the benefits of reduced wiring, rapid diagnostics and easy program modification and maintenance. Of course, since this is a safety controller however, there is a full complement of safeguards against system failure and unauthorized access.



# Programming and visualisation



Mitsubishi's MELSOFT suit of software tools brings productivity and ease of use.

One of the largest cost components of any project is not the control hardware but the time required to create and write the application. Mitsubishi's MELSOFT software solutions help you save time by making it easier to reuse existing work, as well as making interfaces simpler and more intuitive. In addition, MELSOFT provides innovative tools to help users increase their productivity in planning, implementation, service and support.

### ■ Programming

Three software packages are available: one in standard Mitsubishi format, another in compliance with IEC1131.3, and a dedicated process control solution. This enables customers to choose the best solution for their needs. Mitsubishi's programming solutions help you save time by making it easier to reuse existing programming code; they also have simple, intuitive interfaces.

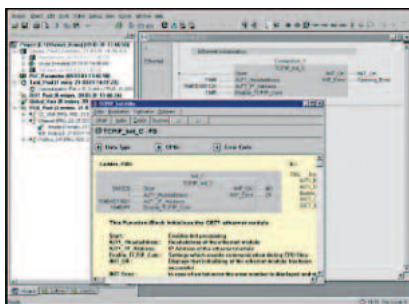

Advanced software packed in an easy to use interface.

### ■ Communication

MELSOFT communication packages are designed to integrate Mitsubishi products with other software packages by using plug-ins or drivers. The user benefits from the reliability and quality of Mitsubishi hardware combined with the familiarity of software tools such as Microsoft Excel, Active X and OPC.

### ■ Visualization

Mitsubishi supplies both SCADA- and PC-based HMI solutions for data analysis, maintenance and linking into other high-end business operations packages.

## Human Machine Interfaces

In addition to software visualization solutions, Mitsubishi Electric offers one of the world's widest ranges of HMI, GOT and IPC technologies. Solutions range from simple small text screens all the way through to high- resolution touch screens and full-fledged industrial PCs, complementing the range and power of System Q.



GOT1000 displays offer high resolution and touch screen technology.

Package	GX IEC Developer	GX Developer	PX Developer	iQ Works*
IEC 61131-3 compliance	Yes	No	No	Yes
Languages	LD/IN/FB/ST/SFC	LD/IN/SFC	LD/IN/SFC	LD/IN/FB/ST/SFC
Simulator	No	Optional	No	Yes
Special function block setup utilities	No	Yes	Yes	Yes
HMI programming	No	No	No	Yes
Motion CPU programming	No	No	No	Yes

\* coming soon LD = Ladder, IN = Instruction, FB = Function block, ST = Structured Text, SFC = Sequential Function Chart

# Plant solutions

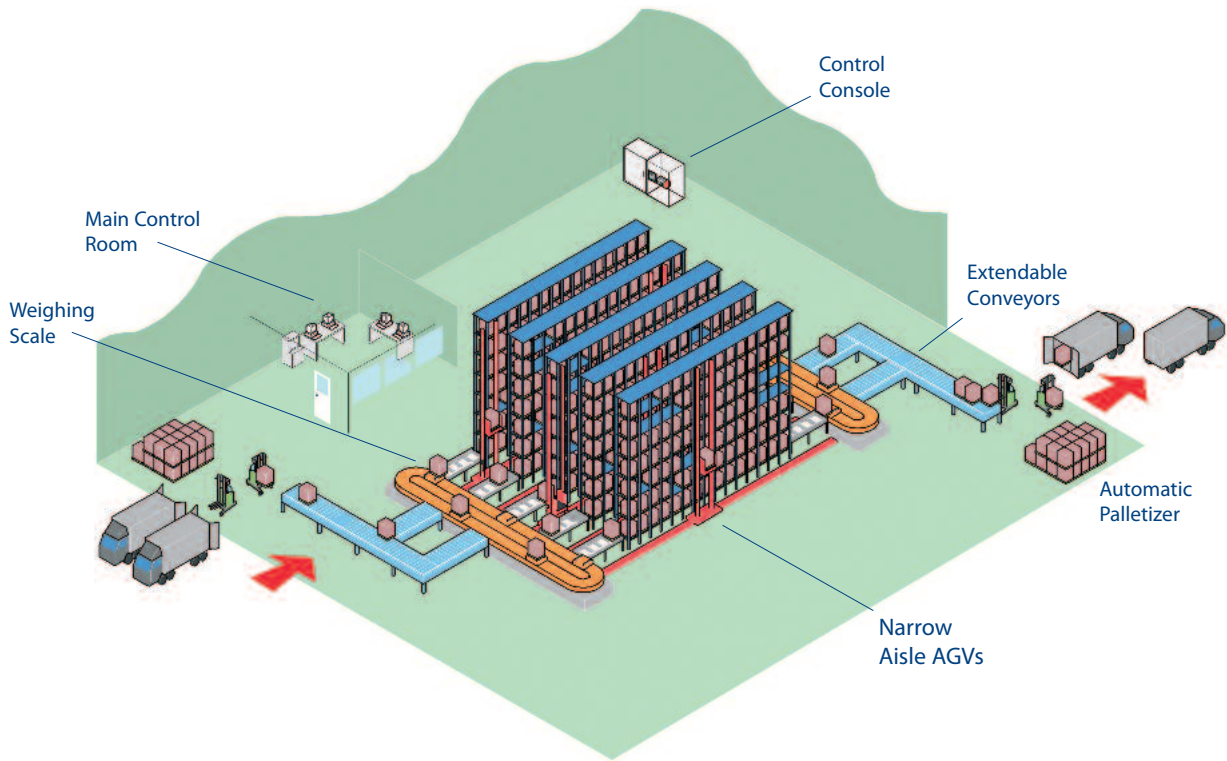

Optimal operation occurs when all elements within a plant are kept constantly running, this can only be achieved with reliable co-ordination and integration.

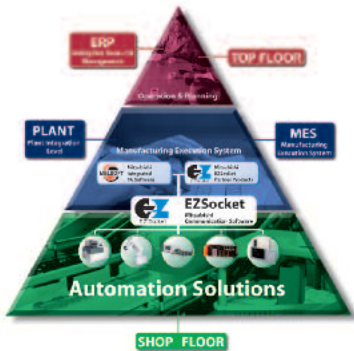

e-F@ctory turns the idea into a reality.

Companies often mull over and discuss factory or plant-wide management solutions for many years – but without ever actually implanting them. After all, they are understandably reluctant to halt production for an extended period while the new system is being fitted, and find the prospect of organizing and planning the whole activity daunting, especially since they often want to implement a new solution all at once.

## e-F@ctory

Mitsubishi Electric's e-F@ctory solution answers a lot of these issues. It is based on the System Q automation platform concept. Thanks to System Q's modular design, it is now much easier to implement plant-wide control based on segmented or manufacturing cell solutions.

## Communication

Plant-wide operations rely on good communication strategies. System Q's automation platform can support over 50 different forms of communication, including standard RS232, fieldbuses, Ethernet, webservers and redundant networks.

## Making life easy

Traditionally, the interface between MES and the production environment has been separated by a layer of management PCs and master PLCs used for concentrating data and cell information. With System Q's automation platform, this structure can be simplified by embedding the PC directly on the same backplane. This removes a layer of management structure as well as simplifying implementation.

Each customer's requirements are different and System Q is designed to offer a wide range of solutions that can be easily adapted. For example, System Q enables the use of local embedded web-server technology, meaning that Ethernet and web-based browsing can be used for capturing data. Moreover, a dedicated MES interface allows System Q to "talk" directly to the MES software without any intermediary devices, reducing implementation and on-going maintenance costs.

# Machine solutions

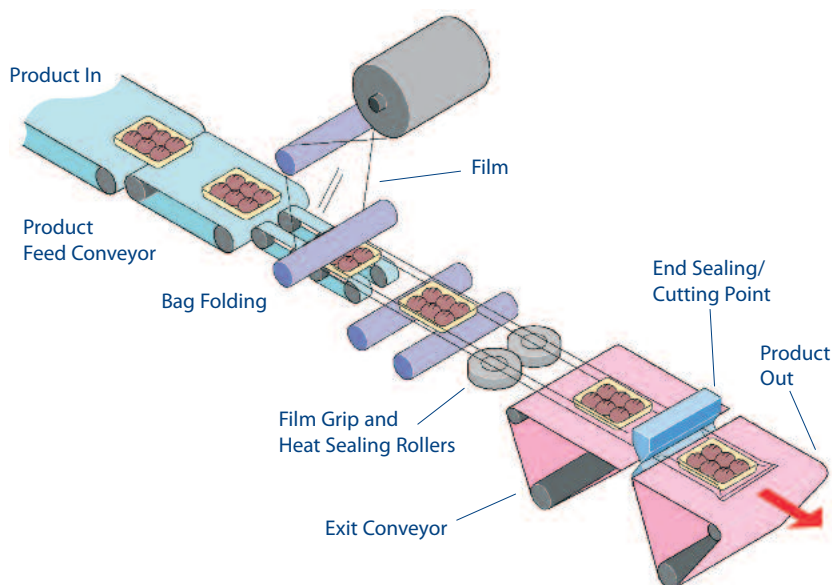

A horizontal packaging machine can present many challenges to the automation engineer.

Each machine presents different challenges to the control system. Sometimes high quantities of I/O are required locally or are networked. Small controller size is often important, while at other times the key factors will be temperature, positioning, or analogue control.

For the machine designer, an ideal solution is to have a standard control philosophy that can be adapted to each machine's individual needs. This is exactly what System Q brings to machine control.

## Compact

Due to its modular design, System Q uses less panel space than many other controllers. In addition, Mitsubishi offers a wide range of high-density I/O cards and analogue modules that are ideal for minimizing installation space. For very compact installations, System Q offers an all-in-one solution comprising a backplane, CPU and power supply which is supported by an extensive range of network options for I/O and devices.

## Flexible

When designing a control system for a given machine, flexibility is often a key requirement. Many machine manufacturers develop ranges of products which require a basic control concept to which additional features can be added as machine performance increases. The System Q automation platform is ideally suited to this.

System Q encompasses a wide range of modules, including more than 22 different types of temperature and analogue modules, 20 different positioning modules, and a wide range of communication devices.



Example of temperature control.

Supporting this are basic and advanced PLC CPUs as well as webservers, PC CPUs, Process CPUs, C Controllers, Motion CPUs and redundant CPUs.

## Easy programming

One of the largest costs in any control solution is the programming and engineering time. System Q overcomes this with user-friendly, intuitive programming tools. In addition, we place great emphasis on reusable program code, employing function blocks and a sequential function chart. Embedded set-up tools support this process, making the configuration of special function modules simple, quick, and easy.



# A world of applications



Plant control solutions

Mitsubishi products are found in an almost infinite variety of industrial, infrastructure and service sector contexts, ranging from critical applications in the pharmaceuticals industry to state-of-the-art leisure and entertainment facilities. Here are just a few examples of recent applications:

- Agriculture
  - Irrigation systems
  - Plant handling systems
  - Sawmills
- Building management
  - Smoke detection monitoring
  - Ventilation and temperature control
  - Lift (elevator) control
  - Automated revolving doors
  - Telephone management
  - Energy management
  - Swimming pool management
- Construction
  - Steel bridge manufacturing
  - Tunnel boring systems

- Food and drink
  - Bread manufacture (mixing/baking)
  - Food processing (washing/sorting/slicing/packaging)
- Leisure
  - Multiplex cinema projection
  - Animated mechatronics (museums/theme parks)
- Medical
  - Respiration machine testing
  - Sterilization
- Pharmaceutical/chemical
  - Dosing control
  - Pollution measurement systems
  - Cryogenic freezing
  - Gas chromatography
  - Packaging
- Plastics
  - Plastic welding systems
  - Energy management systems for injection moulding machines
  - Loading/unloading machines
  - Blow moulding test machines
  - Injection moulding machines
- Printing
- Textiles
- Transportation
  - Sanitation on passenger ships
  - Sanitation on rail rolling stock
  - Fire tender, pump management
  - Waste disposal truck management
- Utilities
  - Waste water treatment
  - Fresh water pumping



Remote management solutions including SCADA, networking, Telemetry and Industrial Modems.

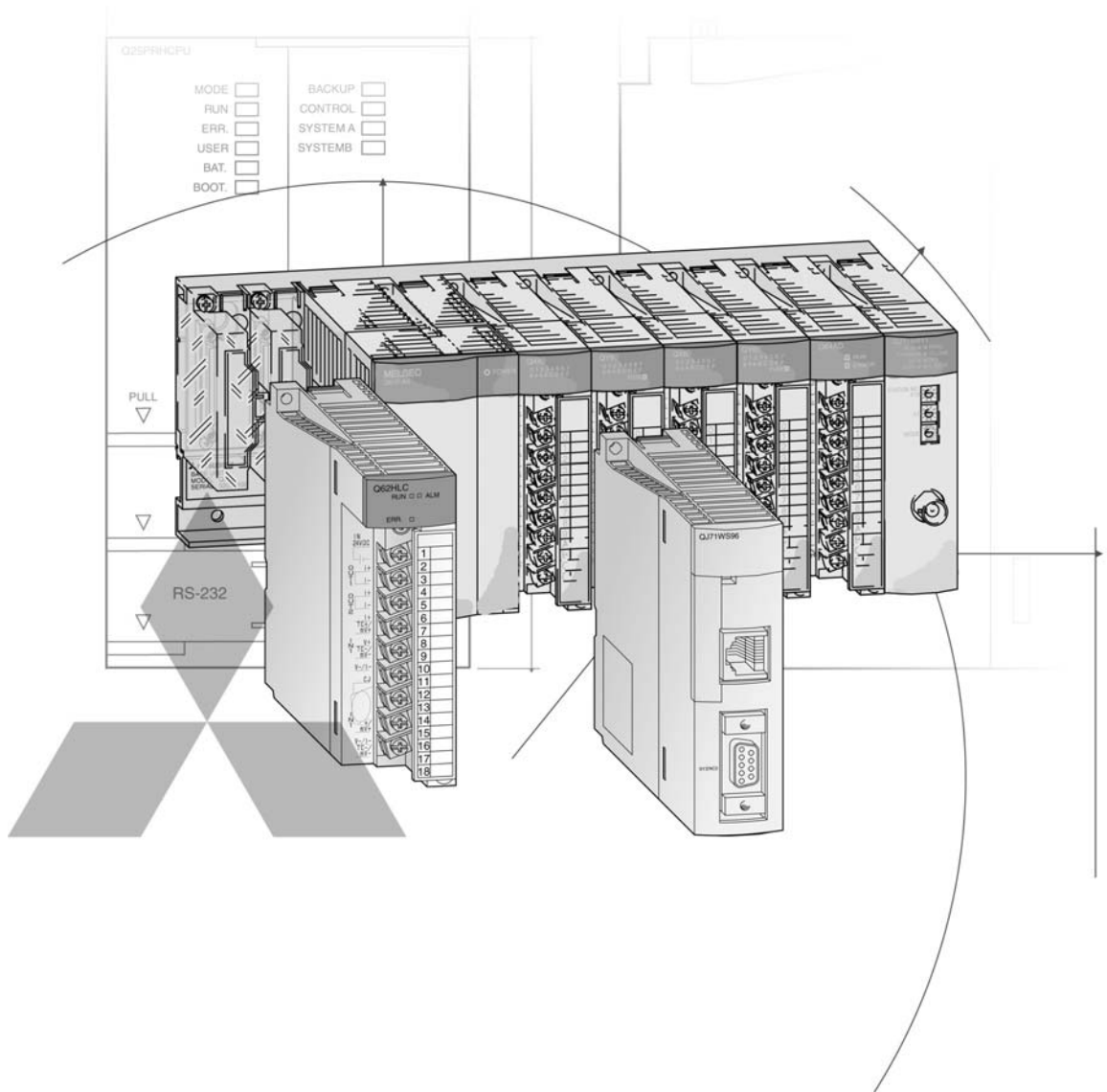

## Technical Information Section



## Further Publications within the PLC Range

### **Brochures**

#### **Brochure FX Family**

Product catalogue for programmable logic controllers and accessories for the MELSEC FX family

#### **Brochure HMI Family**

Product catalogue for operator terminals, supervision software and accessories

#### **Automation Book**

Overview on all Mitsubishi automation products, like frequency inverters, servo/motion, robots etc.

#### **Servo and Motion Systems**

Product catalogue for servo amplifiers and servo motors as well as motion controller and accessories

#### **Brochure Robots Family**

Product catalogue for industrial robots and accessories

---

### **More information?**

This product catalogue is designed to give an overview of the extensive range of System Q of MELSEC PLCs. If you cannot find the information you require in this catalogue, there are a number of ways you can get further details on configuration and technical issues, pricing and availability.

For technical issues visit the [www.mitsubishi-automation.com](http://www.mitsubishi-automation.com) website.

Our website provides a simple and fast way of accessing further technical data and up to the minute details on our products and services. Manuals and catalogues are available in several different languages and can be downloaded for free.

For technical, configuration, pricing and availability issues contact our distributors and partners.

Mitsubishi partners and distributors are only too happy to help answer your technical questions or help with configuration building. For a list of Mitsubishi partners please see the back of this catalogue or alternatively take a look at the "contact us" section of our website.

### **About this product catalogue**

This catalogue is a guide to the range of products available. For detailed configuration rules, system building, installation and configuration the associated product manuals must be read. You must satisfy yourself that any system you design with the products in this catalogue is fit for purpose, meets your requires and conforms to the product configuration rules as defined in the product manuals.

Specifications are subject to change without notice. All trademarks acknowledged.

© Mitsubishi Electric Europe B.V., Factory Automation - European Business Group 2010

## MELSEC System Q

### SYSTEM DESCRIPTION

- ◆ Introduction of the Q system ..... 4
- ◆ Configuration and handling..... 10
- ◆ Networks..... 12

### BASIC COMPONENTS

- ◆ Base units ..... 14
- ◆ Power supply modules..... 16
- ◆ CPU modules..... 17

### DIGITAL MODULES

- ◆ Input modules..... 26
- ◆ Output modules..... 28

### SPECIAL FUNCTION MODULES

- ◆ Analog modules ..... 30
- ◆ Temperature control modules..... 33
- ◆ Load cell module ..... 35
- ◆ Loop control module ..... 36
- ◆ Counter modules ..... 37
- ◆ Positioning modules..... 38
- ◆ Interface modules ..... 43
- ◆ Network modules..... 45
- ◆ High speed data logger module..... 48
- ◆ Interrupt module and high-speed inputs ..... 49

### ACCESSORIES

- ◆ Dummy module and cables ..... 50
- ◆ Memory cards and connectors ..... 52
- ◆ Adapter and batteries..... 53
- ◆ Terminal blocks and extension device box ..... 54
- ◆ Accessory for Q PC..... 55

### DIMENSIONS

- ◆ Dimensions ..... 56

## PROGRAMMING SYSTEMS

### PROGRAMMING

- ◆ MELSOFT software..... 60
- ◆ Visualisation software..... 61
- ◆ Profibus software, iQ Works ..... 62

## APPENDIX

- ◆ Index..... 63

1

2

3

4

5

6

7

## Automation platform MELSEC System Q

### Description

With the MELSEC System Q, MITSUBISHI ELECTRIC presents its most powerful and compact modular PLC, with multiprocessor technology for present and future challenges.

The small size, the communications capability and the high-performance multiprocessing are three important characteristics of the MELSEC System Q. Its compactness ensures that it occupies less space in the switchgear cabinet and its diverse communication facilities guarantee flexibility and openness. Depending on the selected CPU type up to 4096 local and up to 8192 remote I/O points can be addressed. This controller is particularly suitable for performing medium- to high-performance automation tasks.

The individual systems can be installed in different MELSEC and open networks (e.g. MELSECNET, CC-Link, Ethernet or Profibus/DP), enabling them to communicate with one another. The number of I/Os can thus be increased several times.

Thanks to the unique combination possibilities of PLC, process, redundancy, PC/C, and motion CPUs a platform is available that meets every automation task.

### Special features

- up to 4096 local I/Os
- up to 8192 remote I/Os
- interchangeable intelligence
- multiprocessor technology with 31 different CPU types from 9 families (PLC, process, redundancy, universal, special function, PC, motion, CNC and robots)
- wide range of communications facilities
- easy installation
- one system platform for all configurations
- innovative technology for future applications

### The MELSEC PLC Family

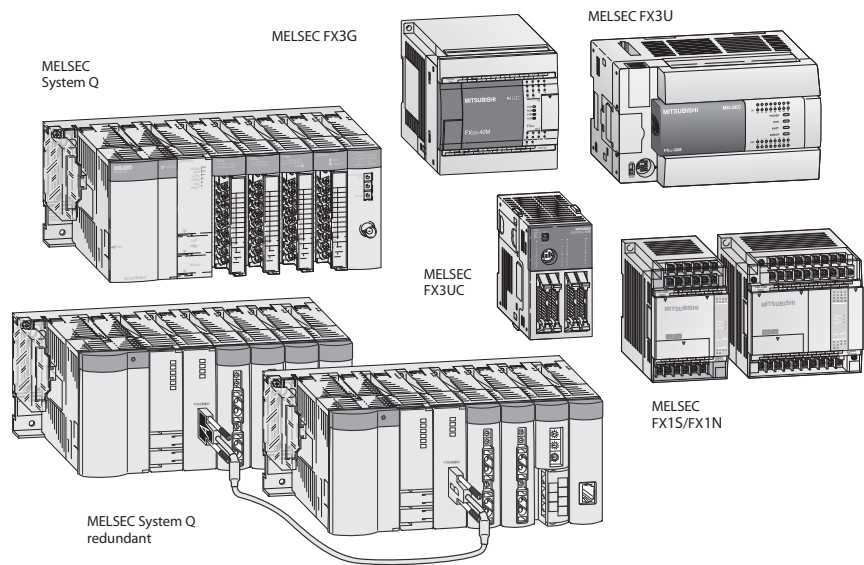

### Expandability and performance

As with other Mitsubishi controllers the power of the MELSEC System Q grows with your application – you simply replace or add a CPU. When using the multi-processor type CPUs the control and communication tasks are shared by up to four CPUs. Every system can provide a maximum capacity of 4,096 local I/Os or 8,192 remote I/Os.

The integrated memory of up to 260 k program steps (which conforms to 1 MB RAM) can easily be expanded by up to 32 MB memory at any time just by slotting in an extension card (not for Q00(J) and Q01).

Flash ROM cards are also available for permanent storage of your controller programs for the Q02 and H type CPUs. An integrated buffer battery protects the data in the CPU's internal RAM against power failures.

The MELSEC System Q offers state-of-the-art performance by a wide range of CPU models, for all applications.

#### Basic PLC CPUs

CPU type	Program capacity	I/O points
Q00JCPU	8 k steps	256/2048
Q00CPU	8 k steps	1024/2048
Q01CPU	14 k steps	1024/2048

#### High-performance CPUs

CPU type	Program capacity	I/O points
Q02CPU	28 k steps	4096
Q02HCPU	28 k steps	4096
Q06HCPU	60 k steps	4096
Q12HCPU	124 k steps	4096
Q25HCPU	252 k steps	4096

#### Universal PLC CPUs

CPU type	Program capacity	I/O points
Q00UCPU	10 k steps	256/8192
Q00UCPU	10 k steps	1024/8192
Q01UCPU	15 k steps	1024/8192
Q02UCPU	20 k steps	2048/8192
Q03UDCPU	30 k steps	4096/8192
Q03UDECPU	30 k steps	4096/8192
Q04UDHCPU	40 k steps	4096/8192
Q04UDEHCPU	40 k steps	4096/8192
Q06UDHCPU	60 k steps	4096/8192
Q06UDEHCPU	60 k steps	4096/8192
Q10UDHCPU	100 k steps	4096/8192
Q10UDEHCPU	100 k steps	4096/8192
Q13UDHCPU	130 k steps	4096/8192
Q13UDEHCPU	130 k steps	4096/8192
Q20UDHCPU	200 k steps	4096/8192
Q20UDEHCPU	200 k steps	4096/8192
Q26UDHCPU	260 k steps	4096/8192
Q26UDEHCPU	260 k steps	4096/8192

#### Process CPUs

CPU type	Program capacity	I/O points
Q02PHCPU	28 k steps	4096/8192
Q06PHCPU	60 k steps	4096/8192
Q12PHCPU	124 k steps	4096/8192
Q25PHCPU	252 k steps	4096/8192

**Redundant PLC CPUs**

CPU type	Program capacity	I/O points
Q12PRHCPU	124 k steps	4096/8192
Q25PRHCPU	252 k steps	4096/8192

**Motion CPUs**

CPU type	Program capacity	I/O points; axes
Q172CPUN	14 k steps	8192; 8
Q172DCPU	14 k steps	8192; 8
Q172HCPU	14 k steps	8192; 8
Q173CPUN	14 k steps	8192; 32
Q173DCPU	14 k steps	8192; 32
Q173HCPU	14 k steps	8192; 32

**Special Purpose CPUs (C, NC, Robot)**

CPU type	Memory capacity	I/O points
Q172DR	2 MB	4096/8192
Q12DCCPU	128 MB	4096/8192
Q173NC	230 kB (600 m)	4096/8192

**PC-CPU**

CPU type	Memory capacity	I/O points
PPC-CPU 852(MS)-128	512 MB	4096/8192

**Equipment Features**

The modular design of MELSEC System Q allows flexible usage in a broad range of applications.

The following modules are available for assembling the system:

To maximize the operational safety, all modules are isolated from the environment by means of optocouplers.

All I/O modules with screw contacts have their own removable terminal blocks which ensures easy handling during installation. The terminal block can be alternatively exchanged for a spring-loaded terminal block (optional).

**Use of digital and special function modules**

The use of digital and analog modules and most special function modules is dependent only on the maximum addressable number of addresses and thus on the CPU used in each case.

**Pulse catch and interrupt modules**

Digital input modules for pulse storage and for processing subroutines

**Digital input/output modules**

For various signal levels with transistor, relay or triac switches

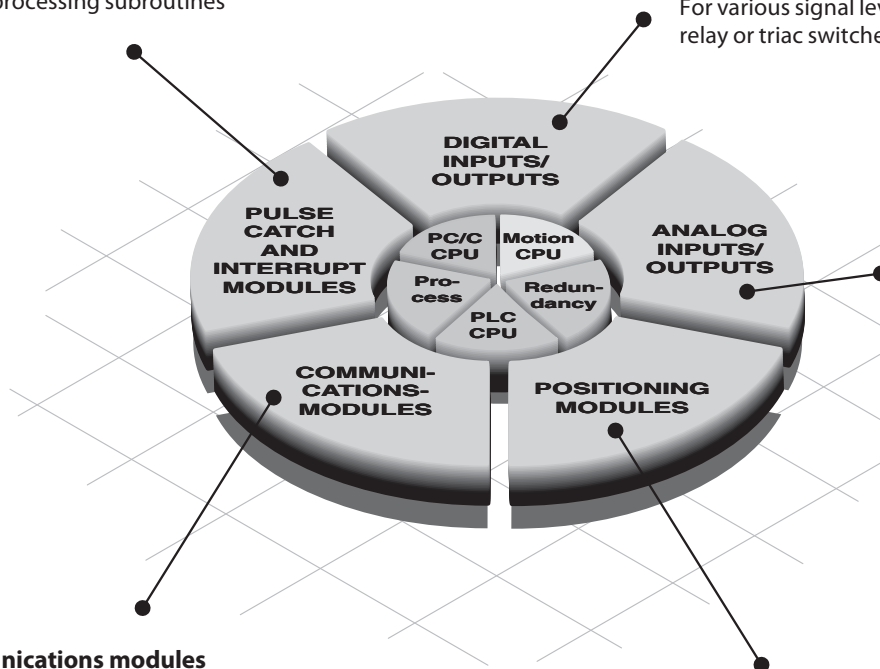

**Analog input/output modules**

For processing current/voltage signals and for temperature value acquisition as well as temperature control with direct connection of Pt100 resistance thermometers or thermocouples. A HART enabled module for current input is also available.

**Communications modules**

Interface modules with RS232/RS422/ RS485 interface for connection of peripherals or for PLC-PLC communication.

**Network modules**

For interfacing with Ethernet, CC-Link, CC-Link IE, Profibus, Modbus TCP/RTU, DeviceNet, AS-Interface and MELSEC networks.

**Positioning modules**

High-speed counter modules with possibility for connection of incremental shaft encoder or multiaxial positioning modules for servo and step drives with up to 8 axes per module.

### Task Management with Multiple PLC CPUs

Multiple MELSEC System Q series PLC CPUs can be used together to allow a single system to execute controls that are different in tact time, e.g. sequence control and data processing.

Thus sequence control and data processing can be distributed to different CPUs.

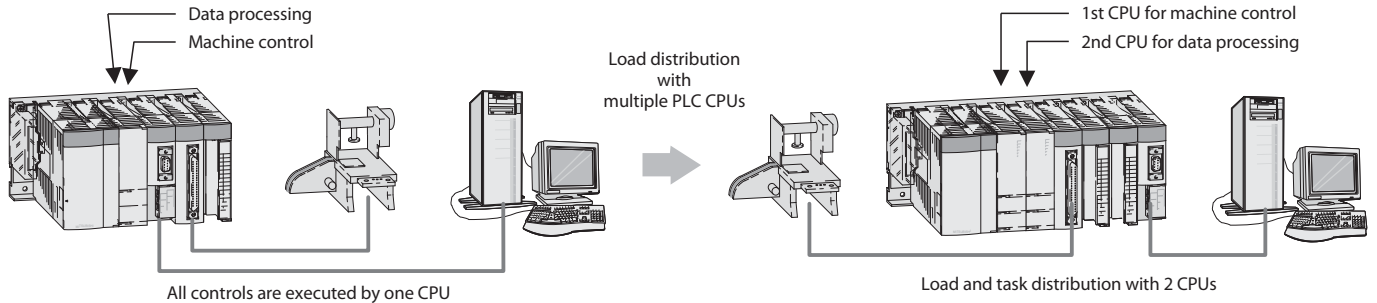

If load in excess of a CPU's processing capability is applied to a large scale system due to a large program size, using multiple CPUs to distribute the load improves the overall performance of the system.

When one process requires fast processing and the other does not, they can be handled respectively by two CPUs, providing stable and rapid control which is unaffected by the other process.

ding stable and rapid control which is unaffected by the other process.

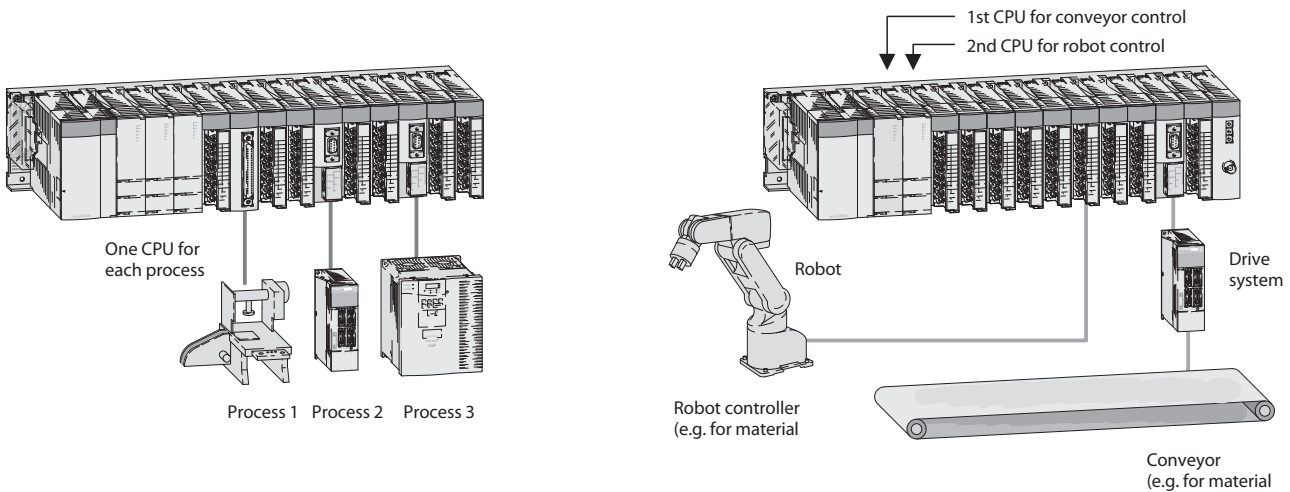

### Integration of Motion CPU and Personal Computer CPU

The System Q has the multiple CPU system function which also permits PLC CPUs and Motion CPUs to be loaded together on one base unit. While data exchange is optimized via the back bus of the base unit, space requirements and system costs are significantly reduced at the same time.

A Motion CPU can use the SSCNET that rapidly controls up to 96 axes in a single system and saves wiring. The personal computer CPU (Q-PC) enables the access to I/O modules and intelligent function modules and the communication of all CPUs with each other. When a PC/C-CPU is used the system can also be controlled with a high-level language like C++ or VB

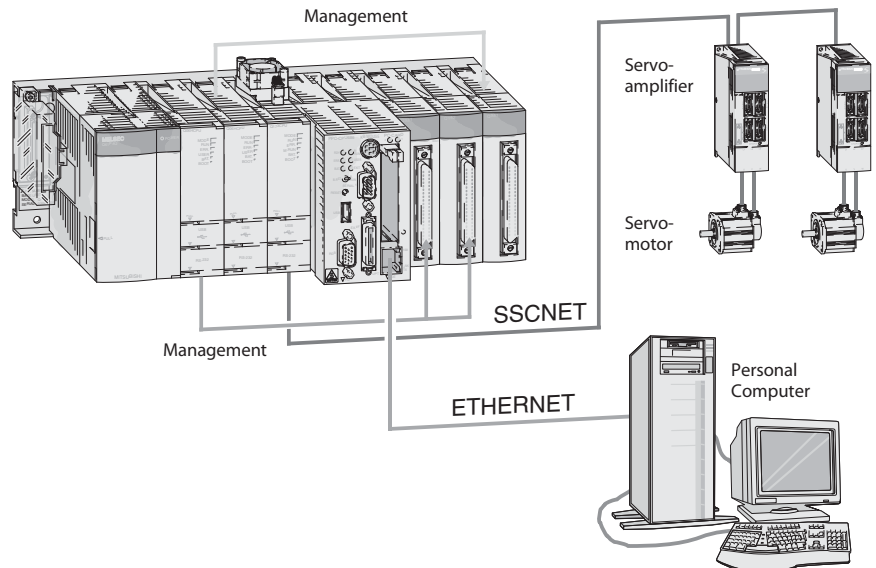



## iQ Platform

Mitsubishi Electric provides all aspects of control on a consolidated automation platform. This platform not only has sequence controllers, but also other various controllers specific to an industry or application area. These are, process controller, C lan-

guage, embedded industrial PC, CNC controller, robot controller and HMI. Together with the abundant I/O that is available for this series, the iQ Platform solution can be applied to almost any kind

of application scope, with productivity kept optimum and reduced TCO being key. This is a true solution for automation, this is iQ Platform.

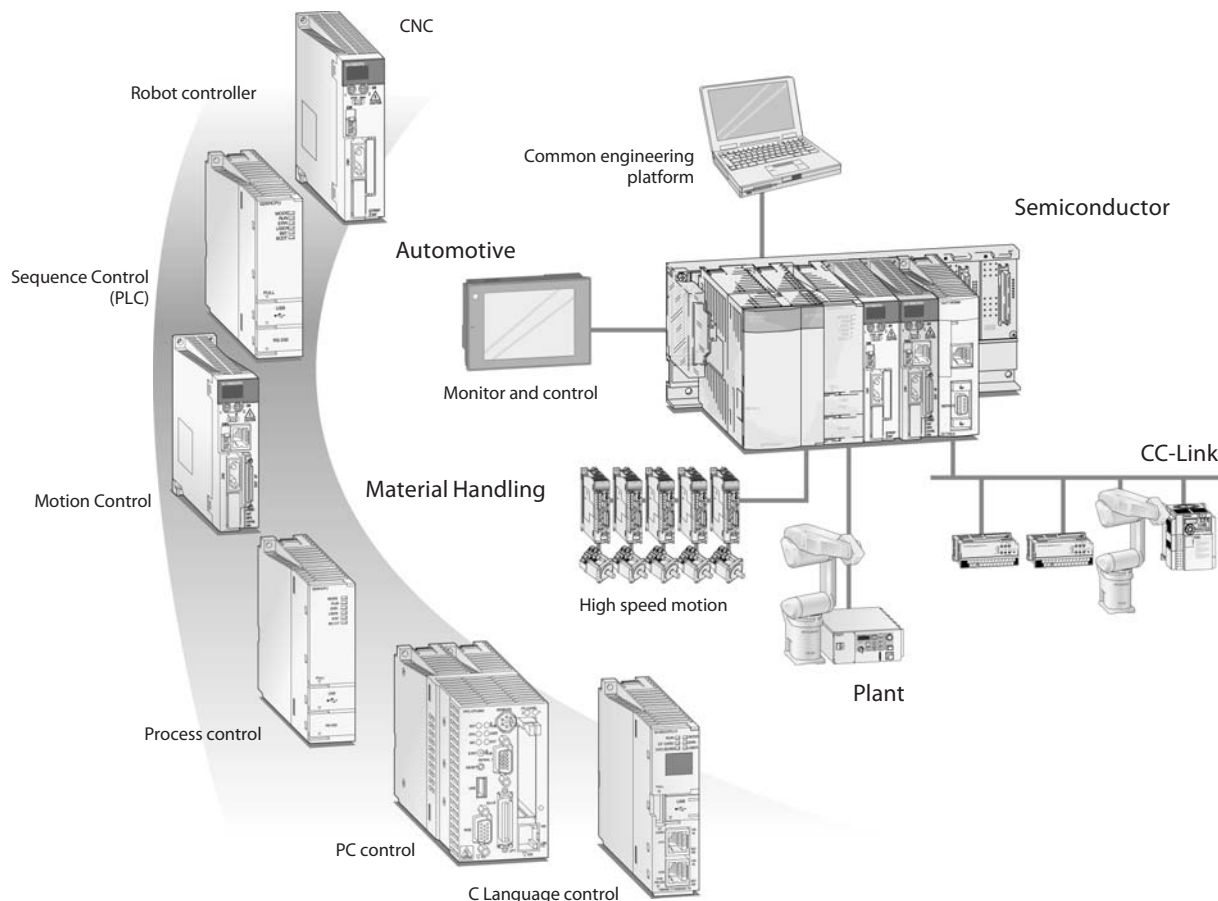

## The MELSEC QS Safety programmable controller

Even with increasing productivity, the safety of workers operating machinery and manufacturing facilities must still always have top priority. The MELSEC System QS PLC is specially designed for managing safety systems.

It is connected to safety devices like Emergency Stop switches and light curtains and has extensive diagnostics functions that enable it to reliably switch safety-critical outputs at the right time to turn machines off in the event of danger.

The actual machinery (conveyor belts, robots etc.) is still controlled by a conventional PLC.

The MELSEC System QS PLC is compliant to the international safety standards EN954-1 Category 4, ISO13849-1 PL e, and IEC61508 (JIS C 0508) SIL 3 and certified by TÜV Rheinland.

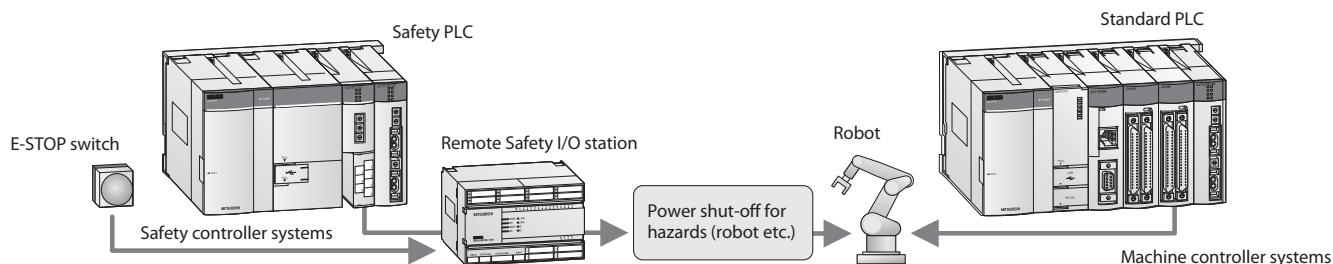

## Redundant CPU

The redundant system prevents the sudden fault. An entire system including the power supply module, CPU and base unit is designed with redundancy. It provides the suitable system for diverse area of automation.

- Even if a failure occurs in the control system, the standby system takes over the control to continue the system operation.
  - The Q Series products, such as I/O, intelligent and network modules, can be used without any changes (except for some modules\*).
  - The remote I/O reduces risks with decentralized control.
  - GX Developer and PX Developer offer simple engineering environment for redundant system settings with the original operability.
- \* There are restrictions on the usable version when configuring a redundant system.

### System configuration example

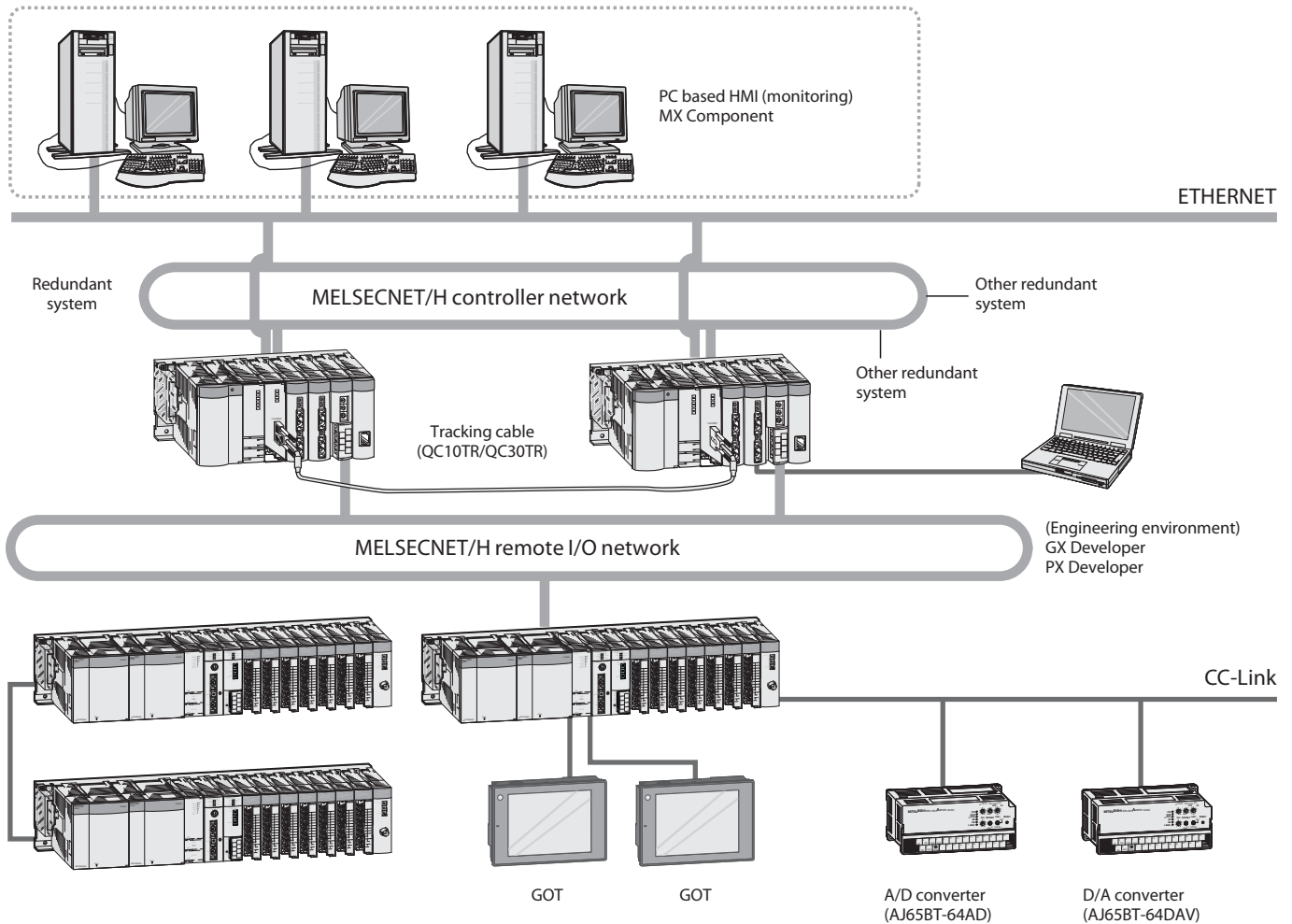

**Easy program modification for both control and standby systems**

- Write programs and parameter files to programmable controllers
- Online change while editing a program

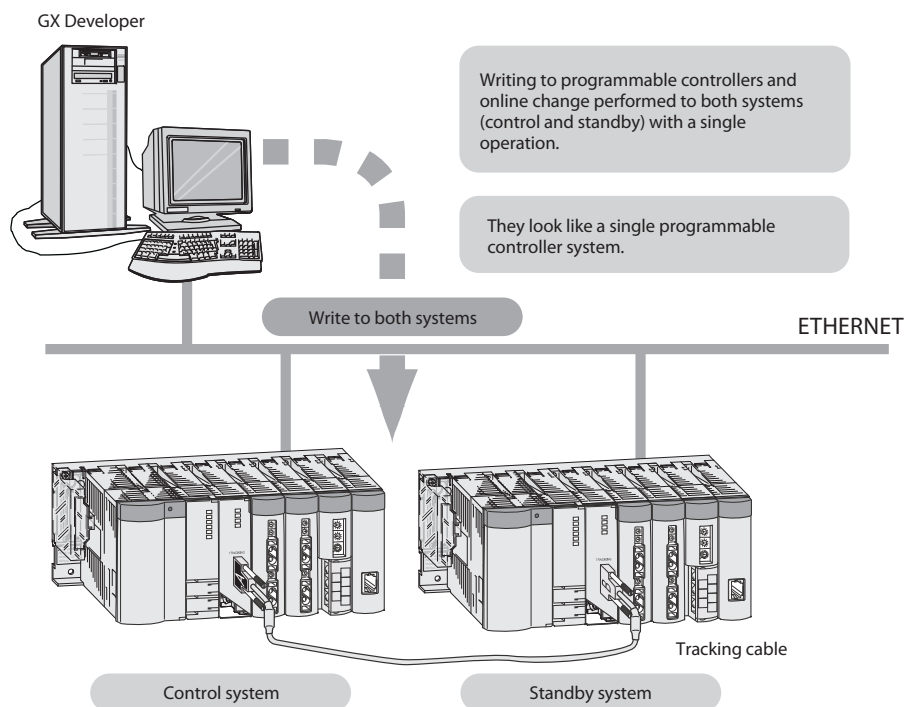

**Continue operations even at system switching**

If system switching occurs due to a stop error inside the CPU, the access target is automatically switched to the other system via the network. This enables continuous operation so that the user need not pay attention to system switching.

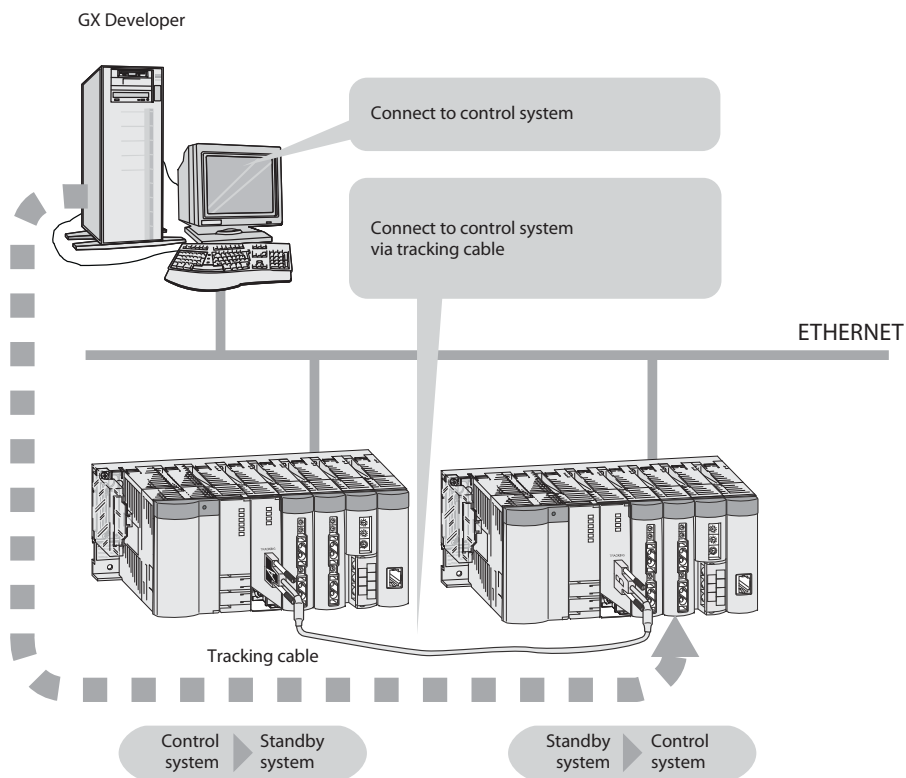

## Configuration

### System structure

The CPU and modules are held in a base unit which has an internal bus connection for communication between the individual modules and the CPUs. The power for the modules inserted in the base unit is delivered by the power supply module.

The base units are available in 4 different versions with 3 to 12 module slots. Each base unit can be supplemented by means of an extension unit providing additional slots.

If you wish to keep open the option of subsequent extension of your PLC or if you have free slots on your base unit, you can insert dummy modules here. They serve to protect the free slots from soiling or from mechanical effects but can also be used for reserving I/O points.

For cabling larger systems and machines - e.g. in a modular design - the use of remote I/O modules offers additional communications facilities.

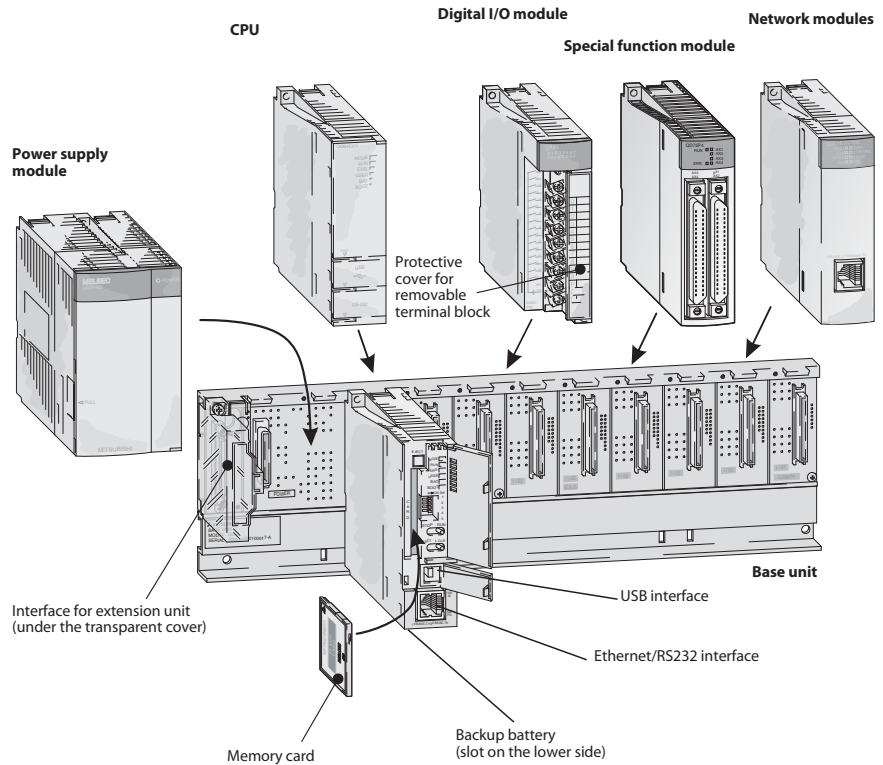

### Extension

The base unit and extension units are simply connected to one another by extension cables.

When the Q52B and Q55B are used these cables also supply the necessary 5V DC power supply to the extension base unit.

Up to seven extension units with up to 64 modules can be connected to base units or extension base units. The extension may be in the horizontal or vertical direction and allows a maximum distance of the extensions cables of 13.2 m.

When choosing the power supply module, the total power consumption of the I/O modules, of the special function modules and of the peripherals must be taken into account. If necessary, an extension unit with a further power supply module should be used.

It is also possible to use a redundant power supply configuration to increase availability.

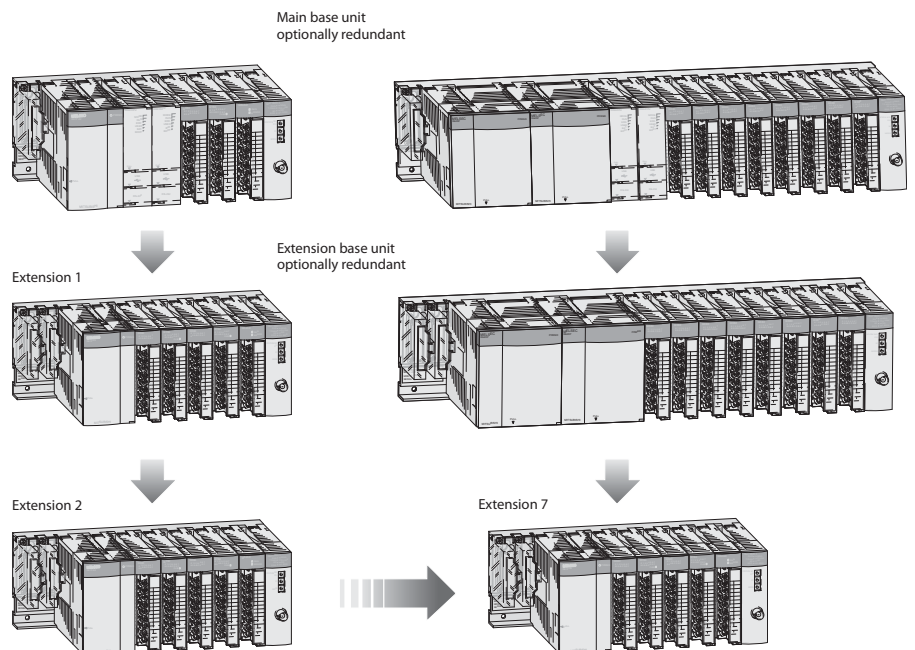



## Module Combinations for Multiple CPU System

### Multiple CPU high speed main base unit (Q3□DB)

CPU 1	CPU 2 to 4	Universal model QCPU			High performance model QCPU	Process CPU	Motion CPU		PC CPU
		Q00U Q01U Q02U	Q03UD (E)/Q04UD (E) H Q06UD (E) H/Q10UD (E) H Q13UD (E) H/Q20UD (E) H Q26UD (E) H	Q02 (H) Q06H Q12H Q25H	Q02PH Q06PH Q12PH Q25PH	Q172D Q173D	Q172H Q173H Q172 Q173		
Universal model QCPU	Q00U	—	—	—	—	—	—	○ ① ③	
	Q01U ②	—	—	—	—	—	—	○ ① ③	
	Q02U	—	—	—	—	—	—	○ ① ③	
	Q03UD (E)	—	●	○	○	●	—	○ ① ③	
	Q04UD (E) H	—	●	○	○	●	—	○ ① ③	
	Q06UD (E) H	—	●	○	○	●	—	○ ① ③	
	Q10UD (E) H	—	●	○	○	●	—	○ ① ③	
	Q13UD (E) H	—	●	○	○	●	—	○ ① ③	
	Q20UD (E) H	—	●	○	○	●	—	○ ① ③	
Q26UD (E) H	—	●	○	○	●	—	○ ① ③		
High Performance model QCPU	Q02 (H)	—	○	○	○	—	—	○ ① ③	
	Q06H	—	○	○	○	—	—	○ ① ③	
	Q12H	—	○	○	○	—	—	○ ① ③	
	Q25H	—	○	○	○	—	—	○ ① ③	

### Main base unit other than (Q3□DB)

CPU 1	CPU 2 to 4	Universal model QCPU			High performance model QCPU	Process CPU	Motion CPU		PC CPU
		Q00U Q01U Q02U	Q03UD (E)/Q04UD (E) H Q06UD (E) H/Q10UD (E) H Q13UD (E) H/Q20UD (E) H Q26UD (E) H	Q02 (H) Q06H Q12H Q25H	Q02PH Q06PH Q12PH Q25PH	Q172D Q173D	Q172H Q173H Q172 Q173		
Universal model QCPU	Q00U	—	—	—	—	—	○ ④ ⑥	○ ① ③ ⑥	
	Q01U ②	—	—	—	—	—	○ ④ ⑥	○ ① ③ ⑥	
	Q02U	—	—	—	—	—	○ ④ ⑥	○ ① ③ ⑥	
	Q03UD (E)	—	○	○	○ ⑦	—	—	○ ① ③ ⑥	
	Q04UD (E) H	—	○	○	○ ⑦	—	—	○ ① ③ ⑥	
	Q06UD (E) H	—	○	○	○ ⑦	—	—	○ ① ③ ⑥	
	Q10UD (E) H	—	○	○	○ ⑦	—	—	○ ① ③ ⑥	
	Q13UD (E) H	—	○	○	○ ⑦	—	—	○ ① ③ ⑥	
	Q20UD (E) H	—	○	○	○ ⑦	—	—	○ ① ③ ⑥	
Q26UD (E) H	—	○	○	○ ⑦	—	—	○ ① ③ ⑥		
High Performance model QCPU	Q02 (H)	—	○	○	○ ⑦	—	○ ⑤ ⑥	○ ① ③ ⑥	
	Q06H	—	○	○	○ ⑦	—	○ ⑤ ⑥	○ ① ③ ⑥	
	Q12H	—	○	○	○ ⑦	—	○ ⑤ ⑥	○ ① ③ ⑥	
	Q25H	—	○	○	○ ⑦	—	○ ⑤ ⑥	○ ① ③ ⑥	

● = available ○ = optional — = not available

Note:

- ① For usable model name, version, etc., please contact your local Mitsubishi sales office or representative.
- ② Q00U, Q01U, or Q02U does not support multiple CPU high-speed communication.
- ③ Only one PC CPU can be used.
- ④ Only one motion CPU can be used.
- ⑤ Cannot be used together with Q03UD(E), Q04UD(E)H, Q06UD(E)H, Q10UD(E)H, Q13UD(E)H, Q20UD(E)H or Q26UD(E)H CPU.
- ⑥ The slim type main base unit (Q3□SB) and redundant power main base unit (Q38RB) cannot be used.
- ⑦ The slim type main base unit (Q3□SB) cannot be used.

## General specifications

General Specifications	Data
Ambient operating temperature	0—+55 °C
Storage temperature	-25—+75 °C
Ambient relative humidity	Max. 95 % (non-condensing)
Protection	IP 20
Noise durability	1500 Vpp with noise generator; 1 μs at 25—60 Hz
Insulation withstand voltage	AC 1500 V, 1 min.
Shock resistance	10 G (3 times each in 3 directions)/EN 61131-2
Vibration resistance	2 G: resistant to vibrations from 10—55 Hz for 2 hours along all 3 axes; 0.5 G for DIN rail mounting/EN 61131-2
Insulation resistance	>5 MΩ (500 V DC)
Ground	Class 3
Environment	Avoid environments containing corrosive gases, install in a dust-free location.
Certifications	UL/CSA/CE/DNV/NK/LR/ABS/GL/RINA/BV

## MELSEC Networks

### TCP/IP ETHERNET

Ready for immediate operation with the worldwide standard TCP/IP protocol. A PC connected to the Ethernet has full access to all PLCs in the Network, all the way down to the I/Os on the production level.

### MELSECNET/10/H

Low-cost cabling, brilliantly simple set-up and maximum availability thanks to redundancy and Floating Master. The maximum coverage is up to 30 km.

### CC-Link/CC-Link Safety

The network for the control and I/O level comprises capabilities like real-time processing and distributed intelligence. Modules of third-party manufacturers can be integrated.

### CC-Link IE

The new CC-Link IE open standard offers maximum performance at maximum availability. It serves firstly as a network for the control level and furthermore implements

the manufacturing level, the motion level and the safety level. In future, the network structure will be uniform at all levels.

### MELSEC FX Peer-to-Peer

The FX-PPN construction enables a network for up to 8 FX2N controllers as clients. A standard twisted-pair cable can be used as the communications media.

Please refer to page 45 for an overview on the available network modules for the MELSEC System Q.

COMMAND LEVEL  
TCP/IP ETHERNET

CONTROL LEVEL  
CC-Link/CC-Link IE  
MELSECNET/10  
MELSECNET/H

PRODUCTION LEVEL  
CC-Link  
MELSEC FX-PPN

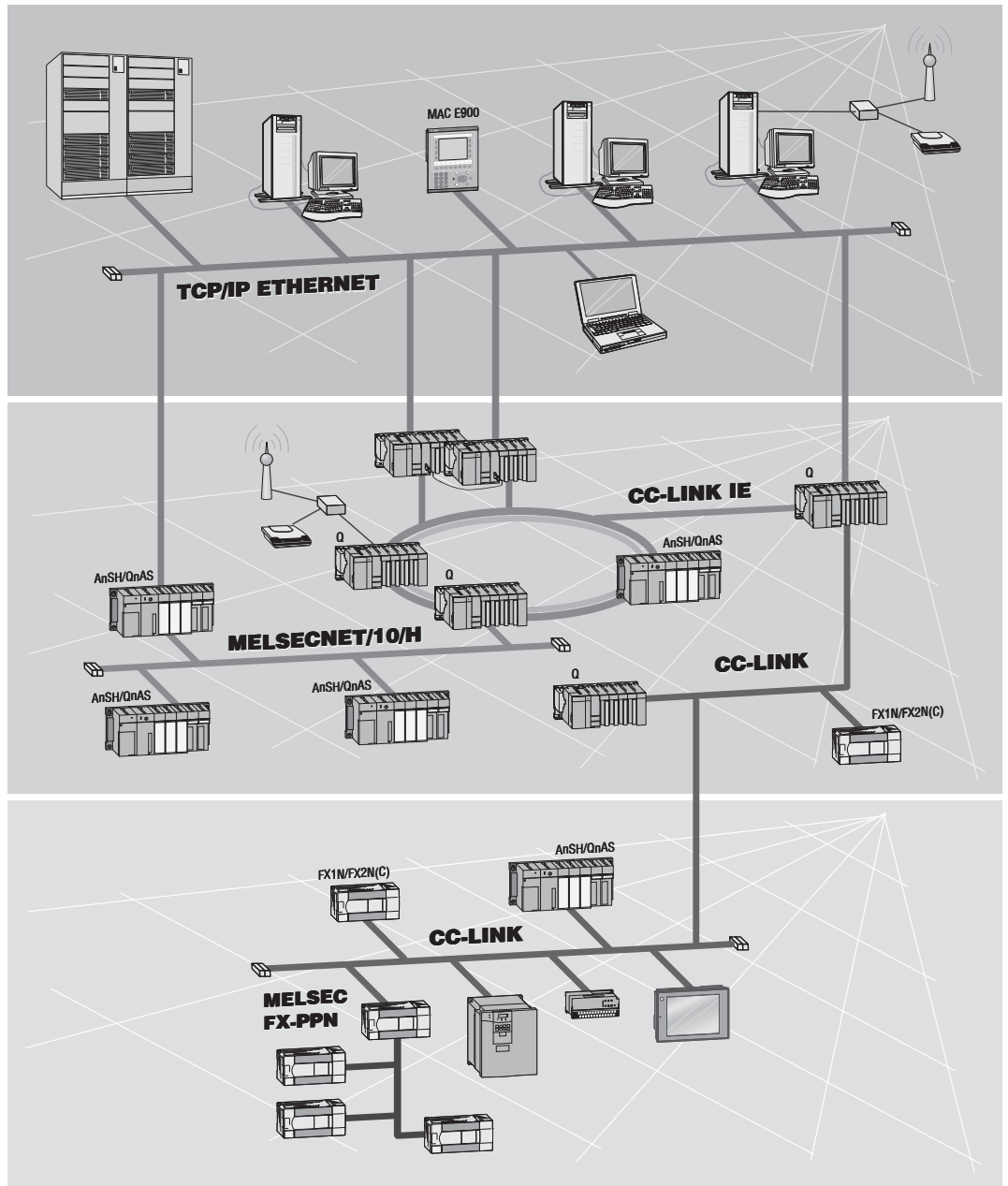

## Open Networks

### TCP/IP ETHERNET

Ready for immediate operation with the worldwide standard TCP/IP protocol. A PC connected to the Ethernet has full access to all PLCs in the Network, all the way down to the I/Os on the production level.

### Modbus/TCP

Non-proprietary protocol using Ethernet, the de facto standard for industrial automation applications

### Modbus RTU

Serial protocol for networking master and slaves

### CC-Link

The network for the control and I/O level comprises capabilities like real-time processing and distributed intelligence. Modules of third-party manufacturers can be integrated.

### Profibus/DP

Enables quick and simple connection of sensors and actuators from different manufacturers to MELSEC PLCs, with data transfer rates of up to 12 Mbaud.

### DeviceNet

Cost-effective CAN-based network communications. Fault-resistant network

structure where components of different manufacturers can be integrated quickly and easily.

### AS-Interface

International standard for the lowest field bus level. Connection of conventional sensors and actuators with two-core cable.

### CANopen

Inexpensive communications network with error-tolerant architecture. Allows fast and simple integration of components from different manufacturers. (FX only)

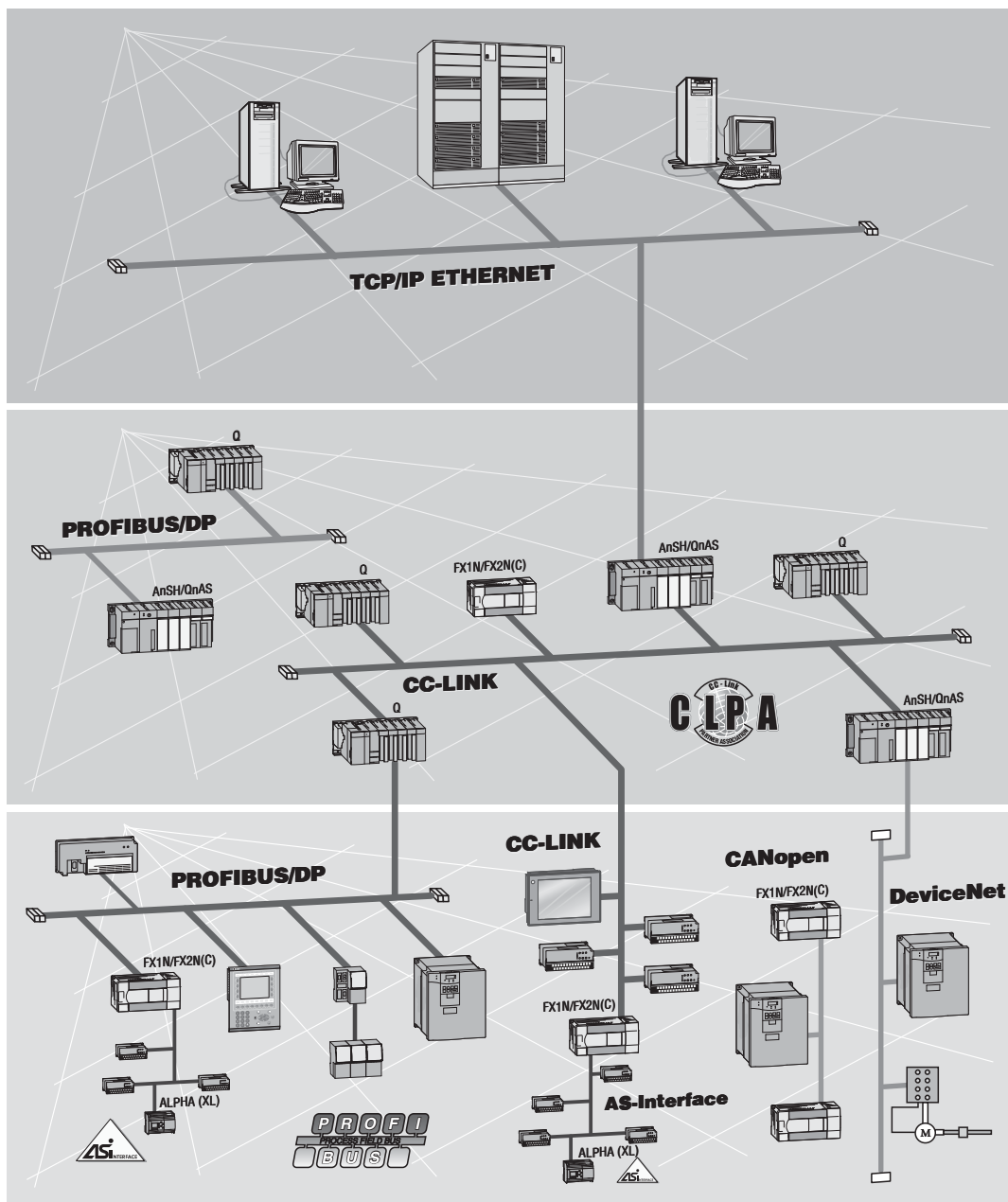

COMMAND LEVEL  
TCP/IP ETHERNET

CONTROL LEVEL  
Profibus/DP  
CC-Link/CC-Link IE  
Modbus/TCP

PRODUCTION LEVEL  
Profibus/DP  
DeviceNet  
AS-Interface  
CC-Link  
CAN Open  
Modbus RTU

**Main Base Units**

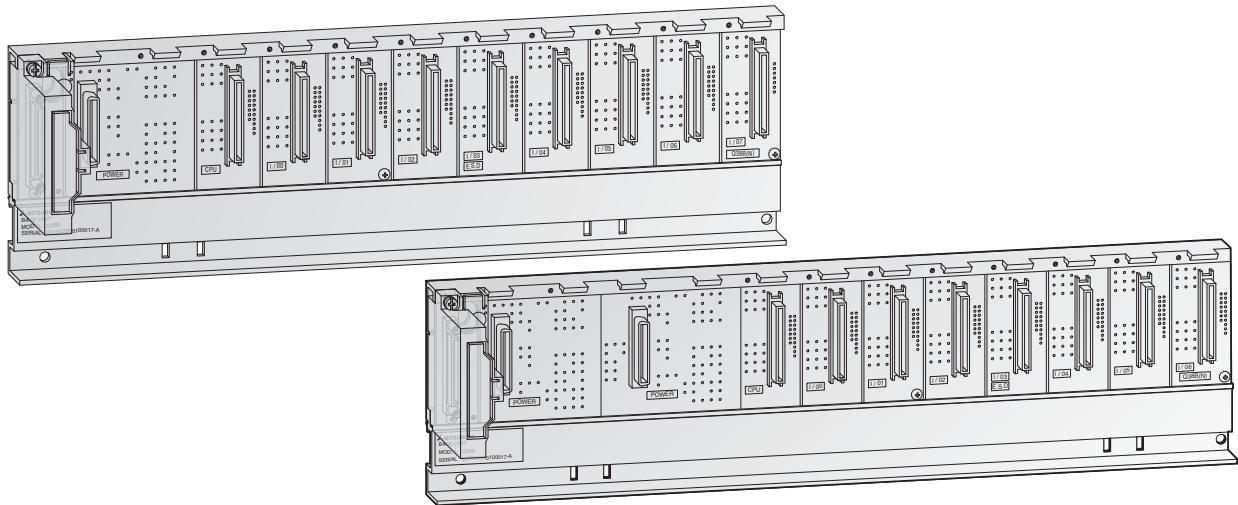

**Main base unit**

The main base unit is used for holding and coupling CPUs, power supply unit, input modules, output modules, special function modules and field bus connections.

**Special features:**

- Module addressing is automatic and it is assumed that the base units have 8 slots. Sixteen addresses are assigned to empty slots and non-existent slots (in base units with less than 8 slots). The automatic addressing can be changed with the I/O Assignment function.
- Base units with slots for two redundant power supplies increase the availability of the system.
- The units are mounted by means of screws or on a profiled rail with an integrated adapter.

Specifications	Q32SB	Q33B-E	Q33SB	Q35B-E	Q35SB	Q38B-E	Q38DB*	Q38RB-E	Q312B-E	Q312DB*	
Slots for I/O modules	2	3	3	5	5	8	8	8	12	12	
Slots for power supply modules	1	1	1	1	1	1	1	2	1	1	
Installation	All base units provide installation holes for M4 screws.										
Dimensions (WxHxD)	mm	114x98x18.5	189x98x44.1	142x98x18.5	245x98x44.1	197.5x98x18.5	328x98x44.1	328x98x44.1	439x98x44.1	439x98x44.1	
<b>Order information</b>	Art. no.	147273	136369	147284	127586	147285	127624	207608	157573	129566	207609
Accessories	Connection cables (refer to page 50); adapter for DIN rail mounting (refer to page 54)										

\* These base units are required for the new iQ Platform motion, NC and robot CPUs.

**Safety main base unit**

The safety main base unit holds and connects the Safety CPU and up to two CC-Link Safety Master Modules and Ethernet modules.

**Special features:**

- Automatic module addressing
- The base unit is mounted by means of screws or on a profiled rail with an integrated adapter.

Specifications	Q5034B-E	
Slots for I/O modules	4	
Slots for power supply modules	1	
Internal power consumption (5 V DC)	0.095 A	
Installation	Provides installation holes for M4 screws.	
Dimensions (WxHxD)	mm	245x98x44.1
<b>Order information</b>	Art. no.	203206
Accessories	Connection cables (refer to page 50); adapter for DIN rail mounting (refer to page 54)	



## Extension Base Units

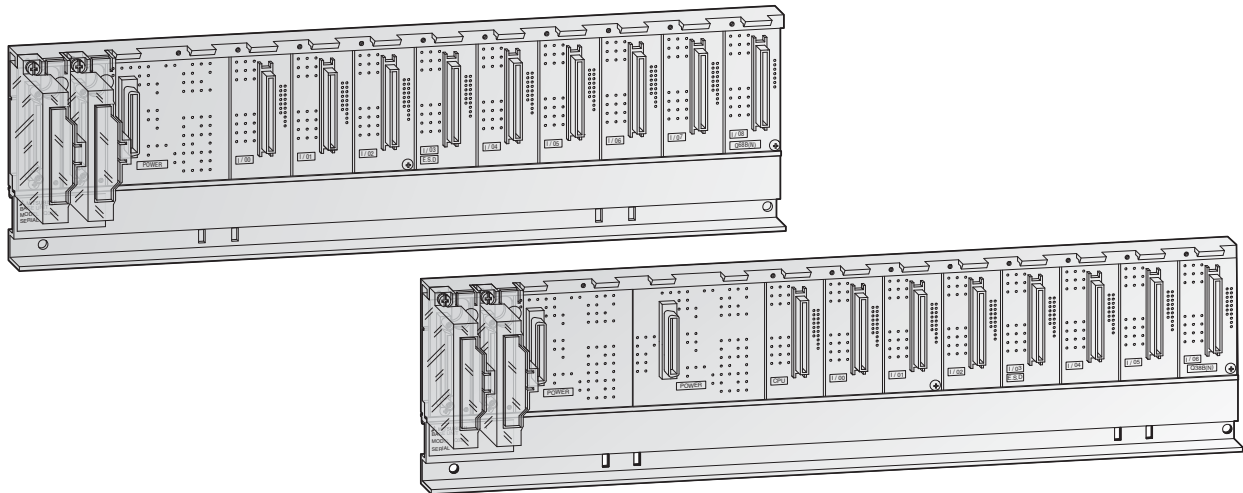

The extension base units are connected to the main base unit by means of assembled bus cables. Thus, a Q system can be expanded to max. 7 extension units with up to 64 I/O modules.

The extension units provide a slot for their own power supply module.

With the redundant type extension base unit Q65WRB, I/O modules can be directly connected to a redundant system.

### Special features:

- Q6\*B extension units provide a slot for their own power supply module
- A total of max.7 extension units can be connected to a main base unit with up to 64 I/O modules for a single system
- The maximum distance from the first to the last base unit is 13.2 m.
- Base units with slots for two redundant power supplies increase the availability of the system.

An extension base unit with a power supply module must be used in the following cases:

- If the power consumption of the inserted modules exceeds the capacity of the power supply module on the base unit.
- If the voltage drops below 4.75 V between the base unit and the extension unit.

Specifications	Q52B	Q55B	Q63B	Q65B	Q68B	Q68RB	Q612B	Q65WRB	
Slots for power supply modules	—	—	1	1	1	2	1	1	
Slots for I/O modules	2	5	3	5	8	8	12	5	
Installation	All base units provide installation holes for M4 screws.								
Weight	kg	0.14	0.23	0.23	0.25	0.35	0.45	0.52	
Dimensions (WxHxD)	mm	106x98x44.1	189x98x44.1	189x98x44.1	245x98x44.1	328x98x44.1	439x98x44.1	439x98x44.1	
Order information	Art. no.	140376	140377	136370	129572	129578	157066	129579	210163
Accessories	Connection cables (refer to page 50); adapter for DIN rail mounting (refer to page 54)								

**Power Supply Modules**

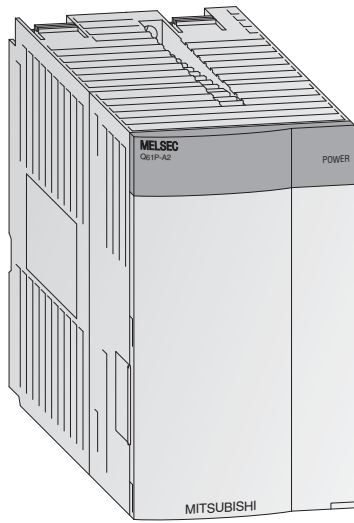

**Power supply modules**

The power supply modules supply the voltages required for operation to the the individual modules. The choice is dependent on the power consumption of the individual modules (this is especially important when using multiple CPUs.)

**Special features:**

- The readiness for operation is indicated by a LED.
- By use of the power supply Q63P it is possible that controllers can be supplied by means of additional 24 V DC output.
- The power supply modules Q62P can be used world-wide because they support the wide input range from 100 to 240 V AC at 50/60 Hz.
- The Q63RP and Q64RP power supplies can be used with all CPUs (except the Q00JCPU) to increase the system availability level. All redundant power supplies can be replaced while the system is in RUN mode without interrupting control operation.
- Two redundant power supplies in a redundant base unit are required for a redundant power supply configuration.

Specifications		Q61P	Q61P-D	Q61SP	Q62P	Q63P	Q63RP	Q64PN	Q64RP	QS061P-A1	QS061P-A2	
Input voltage	(+10%, -15%) V AC	85-264	100-240	85-264	100-240	—	—	100-240	100-240	100-120	200-240	
	(+30%, -35%) V DC	—	—	—	—	24	24	—	—	—	—	
Input frequency	Hz	50/60 (±5%)	50/60 (±5%)	50/60 (±5%)	50/60 (±5%)	—	—	50/60 (±5%)	50/60 (±5%)	50/60 (±5%)	50/60 (±5%)	
Inrush current		20 A within 8 ms	20 A within 8 ms	20 A within 8 ms	20 A within 8 ms	81 A within 1 ms	150 A within 1 ms	20 A within 1 ms	20 A within 1 ms	20 A within 8 ms	20 A within 8 ms	
Max. input apparent power		120 VA	130 VA	40 VA	105 VA	45 W	65 W	160 VA	160 VA	125 VA	125 VA	
Rated output current	5 V DC	A	6	2	3	6	8.5	8.5	8.5	6	6	
	24 V DC ±10%	A	—	—	0.6	—	—	—	—	—	—	
Overcurrent protection	5 V DC	A	≥ 6.6	≥ 6.6	≥ 2.2	≥ 3.3	≥ 5.5	≥ 5.5	≥ 9.9	≥ 6.6	≥ 6.6	
	24 V DC	A	—	—	—	≥ 0.66	—	—	—	—	—	
Overvoltage protection	5 V DC	V	5.5-6.5	5.5-6.5	5.5-6.5	5.5-6.5	5.5-6.5	5.5-6.5	5.5-6.5	5.5-6.5	5.5-6.5	
Efficiency		≥ 70%	≥ 70%	≥ 65%	≥ 70%	≥ 70%	≥ 65%	≥ 70%	≥ 65%	≥ 70%	≥ 70%	
Insulation withstand voltage	Between primary and 5 V DC	2830 V AC, 1 min.	2830 V AC, 1 min.	2830 V AC, 1 min.	2830 V AC, 1 min.	500 V AC, 1 min.	500 V AC, 1 min.	2830 V AC, 1 min.	2830 V AC, 1 min.	2830 V AC, 1 min.	2830 V AC, 1 min.	
	Between primary and 24 V DC	—	—	—	2830 V AC, 1 min.	—	—	—	—	—	—	
Max. compensation time at power failure	ms	20	20	20	20	10	10	20	20	20	20	
Power indicator		All modules possess a power LED display.										
Terminal screw size		All modules possess terminal screw size M 3.5 x 7 mm.										
Applicable wire size		0.75-2mm <sup>2</sup> (AWG 18-14)	0.75-2mm <sup>2</sup> (AWG 18-14)	0.75-2mm <sup>2</sup> (AWG 18-14)	0.3-2mm <sup>2</sup> (AWG 18-14)	0.3-2mm <sup>2</sup> (AWG 16-22)	0.75-2mm <sup>2</sup> (AWG 16-22)	0.75-2mm <sup>2</sup> (AWG 11-22)	0.75-2mm <sup>2</sup> (AWG 11-22)	0.75-2mm <sup>2</sup>	0.75-2mm <sup>2</sup>	
Weight	kg	0.30	0.30	0.39	0.50	0.47	0.40	0.47	0.47	0.40	0.40	
Dimensions (WxHxD)	mm	55.2x98x90	55.2x98x90	27.4x98x104	55.2x98x90	55.2x98x90	83x98x115	55.2x98x115	55.2x98x115	55.2x98x115	55.2x98x115	
Order information	Art. no.	190235	221860	147286	140379	136371	166091	217627	157065	203207	203208	

■ PLC CPU Modules

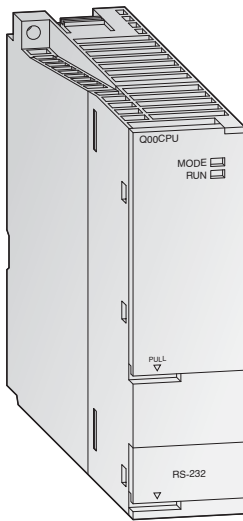

**The basic PLC CPUs**

The CPU modules of the MELSEC System Q are available as single and multi processor CPUs through which they achieve a wide application range. The performance of the controller here grows with the application by simply replacing the CPU (except Q00J).

While Q00CPU and Q01CPU are classical separate CPUs, the Q00JCPU forms an inseparable unit consisting of CPU, power supply and base unit and thus enables a low-priced entry into the modular PLC technology.

The standard CPUs were developed especially for applications where a compact system configuration easily to be realized is to the fore.

**Special features:**

- Every CPU is equipped with an RS232C interface for easy programming and monitoring from a personal computer or operating panel.
- Integrated Flash ROMs for memory operation without additional memory cards
- Processing the inputs and outputs with refresh mode

Specifications	Q00JCPU-E	Q00CPU	Q01CPU
Type	Combination of CPU module (single processor), 5 slot base unit and power supply	CPU module (multi processor)	CPU module (multi processor)
I/O points	256/2048	1024/2048	1024/2048
CPU self-diagnostic functions	CPU error detection, Watch Dog, battery error detection, memory error detection, program check, power supply error detection, fuse error detection		
Multi processor operation	Not possible	With PPC-CPU, Q172CPUN, Q173CPUN only	With PPC-CPU, Q172CPUN, Q173CPUN only
Battery buffer	All CPU modules are fitted with a lithium-battery with a life expectancy of 5 years.		
Memory type	ROM	RAM, ROM	RAM, ROM
Memory capacity	Overall	58 kByte	94 kByte
	Max. for PLC program	8 k steps (32 kByte)	8 k steps (32 kByte)
Program cycle period	0.20 μs/log. instruction	0.16 μs/log. instruction	0.10 μs/log. instruction
Timer (T)	512	512	512
Counter (C)	512	512	512
Internal/special relay (M)	8192	8192	8192
Data register/special register (D)	11136	11136	11136
File register (R) <sup>①</sup>	—	32768	32768
Interrupt pointer (I)	128	128	128
Pointer (P)	300	300	300
Annunciator (F)	1024	1024	1024
Index register (Z)	10	10	10
Link relay (B)/link register (W)	2048/2048	2048/2048	2048/2048
Number of connectable extensions	2	4	4
Max. number of insertable modules	16	24	24
Internal power consumption (5 V DC)	mA 220	250	270
Weight	kg 0.66 <sup>②</sup>	0.13	0.13
Dimensions (WxHxD)	mm 245x98x98 <sup>②</sup>	27.4x98x89.3	27.4x98x89.3
<b>Order information</b>	Art.no. 140378	138323	138324
Accessories	—		

<sup>①</sup> Number depends on memory configuration. <sup>②</sup> All specifications refer to the entire unit incl. base unit and power supply unit.

**High-performance PLC CPUs**

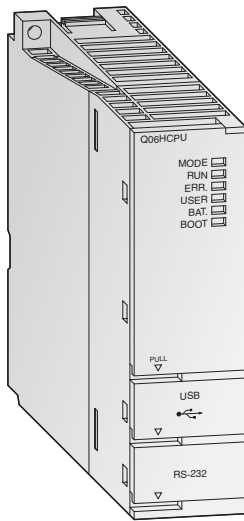

With the high-performance CPUs a high processing speed and expandability are to the fore. They provide a great variety of functions and an even optimized programming and debugging environment to ensure a flexible response to all systems.

**Special features:**

- Every multi processor H-CPU is equipped with an USB interface for easy programming and monitoring from a personal computer.
- Processing the inputs and outputs with refresh mode
- Floating point arithmetic according to IEEE 754
- Special statements for processing PID control loops
- Mathematical functions, such as angle/exponential functions and logarithm
- Hot-swap module replacement in RUN mode (with process CPUs)
- Multi processor mode is possible with up to 4 CPU modules.

Specifications	Q02CPU	Q02HCPU	Q06HCPU	Q12HCPU	Q25HCPU	
Type	Multi processor CPU module					
I/O points	4096/8192	4096/8192	4096/8192	4096/8192	4096/8192	
CPU self-diagnostic functions	CPU error detection, Watch Dog, battery error detection, memory error detection, program check, power supply error detection, fuse error detection					
Multiprocessor mode	Up to 4 CPU modules can be used in combination on one base unit.					
Battery buffer	All CPU modules are fitted with a lithium-battery with a life expectancy of 5 years.					
Memory type	RAM, ROM, FLASH					
Memory capacity	Overall	≤ 32 MByte	≤ 32 MByte	≤ 32 MByte	≤ 32 MByte	
	Max. for PLC program	28 k steps (112 kByte)	28 k steps (112 kByte)	60 k steps (240 kByte)	124 k steps (496 kByte)	252 k steps (1008 kByte)
Program cycle period	79 ns/ log. instruction	34 ns/ log. instruction	34 ns/ log. instruction	34 ns/ log. instruction	34 ns/ log. instruction	
Timer (T)	2048	2048	2048	2048	2048	
Counter (C)	1024	1024	1024	1024	1024	
Internal/special relay (M)	8192	8192	8192	8192	8192	
Data register/special register (D)	12288	12288	12288	12288	12288	
File register (R) ①	32768 / max. 1042432	65536 / max. 1042432	65536 / max. 1042432	131072 / max. 1042432	131072 / max. 1042432	
Interrupt pointer (I)	256	256	256	256	256	
Pointer (P)	4096	4096	4096	4096	4096	
Annunciator (F)	2048	2048	2048	2048	2048	
Index register (Z)	16	16	16	16	16	
Link relay (B)/link register (W)	8192/8192	8192/8192	8192/8192	8192/8192	8192/8192	
Number of connectable extensions	7	7	7	7	7	
Max. number of insertable modules	64	64	64	64	64	
Internal power consumption (5 V DC)	mA 600	640	640	640	640	
Max. compensation time at power failure	ms	Varies according to the type of power unit				
Weight	kg 0.20	0.20	0.20	0.20	0.20	
Dimensions (WxHxD)	mm 27.4x98x89.3	27.4x98x89.3	27.4x98x89.3	27.4x98x89.3	27.4x98x89.3	
<b>Order information</b>	Art. no.	132561	127585	130216	130217	130218
Accessories	Memory cards (refer to page 52)					

① Number depends on memory configuration



■ Universal PLC CPUs

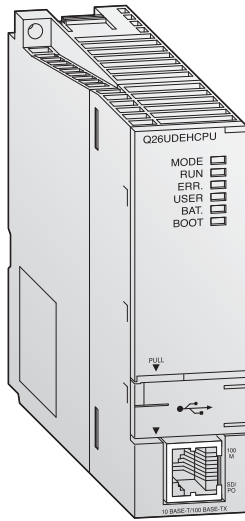

These universal PLC CPUs are the latest generation of modular CPUs for the MELSEC System Q controller platform and they are the foundation of the iQ Platform system. They can be combined with the motion, robot and NC CPUs to configure scalable and highly flexible modular automation systems.

**Special features:**

- Integrated mini USB interface for programming
- Integrated Ethernet interface for efficient communication with the nUDEH modules
- Extremely fast bit processing, 9.5 ns
- High-speed data access

Specifications	Q00UJCPU	Q00UCPU	Q01UCPU	Q02UCPU	Q03UDCPU, Q03UDECPU
Type	Multi processor CPU module				
I/O points	256/8192	1024/8192	1024/8192	2048/8192	4096/8192
CPU self-diagnostic functions	CPU error detection, Watch Dog, battery error detection, memory error detection, program check, power supply error detection, fuse error detection				
Battery buffer	All CPU modules are fitted with a lithium-battery with a life expectancy of 5 years.				
Memory type	RAM, ROM, FLASH	RAM, ROM, FLASH	RAM, ROM, FLASH	RAM, ROM, FLASH	RAM, ROM, FLASH
Memory capacity	Overall	≤ 32 MByte	≤ 32 MByte	≤ 32 MByte	≤ 32 MByte
	Max. for PLC program	10 k steps (40 kByte)	10 k steps (40 kByte)	15 k steps (60 kByte)	20 k steps (80 kByte)
Program cycle period	120 ns/log. instruction	80 ns/log. instruction	60 ns/log. instruction	40 ns/log. instruction	20 ns/log. instruction
Dimensions (WxHxD)	mm 245x98x98	27.4x98x89.3	27.4x98x89.3	27.4x98x89.3	27.4x98x89.3
<b>Order information</b>	Art. no. 221575	221576	221577	207604	207605, 217899

Specifications	Q04UDHCPU, Q04UDEHCPU	Q06UDHCPU, Q06UDEHCPU	Q10UDHCPU, Q10UDEHCPU	Q13UDHCPU, Q13UDEHCPU	Q20UDHCPU, Q20UDEHCPU	Q26UDHCPU, Q26UDEHCPU
Type	Multi processor CPU module					
I/O points	4096/8192	4096/8192	4096/8192	4096/8192	4096/8192	4096/8192
CPU self-diagnostic functions	CPU error detection, Watch Dog, battery error detection, memory error detection, program check, power supply error detection, fuse error detection					
Battery buffer	All CPU modules are fitted with a lithium-battery with a life expectancy of 5 years.					
Memory type	RAM, ROM, FLASH	RAM, ROM, FLASH	RAM, ROM, FLASH	RAM, ROM, FLASH	RAM, ROM, FLASH	RAM, ROM, FLASH
Memory capacity	Overall	≤ 32 MByte	≤ 32 MByte	≤ 32 MByte	≤ 32 MByte	≤ 32 MByte
	Max. for PLC program	40 k steps (160 kByte)	60 k steps (240 kByte)	100 k steps (400 kByte)	130 k steps (520 kByte)	200 k steps (800 kByte)
Program cycle period	9.5 ns/log. instruction	9.5 ns/log. instruction	9.5 ns/log. instruction	9.5 ns/log. instruction	9.5 ns/log. instruction	9.5 ns/log. instruction
Dimensions (WxHxD)	mm 27.4x98x89.3	27.4x98x89.3	27.4x98x89.3	27.4x98x89.3	27.4x98x89.3	27.4x98x89.3
<b>Order information</b>	Art. no. 207606, 217900	207607, 215808	221578, 221579	217619, 217901	221580, 221581	217620, 217902

**Process CPU Modules**

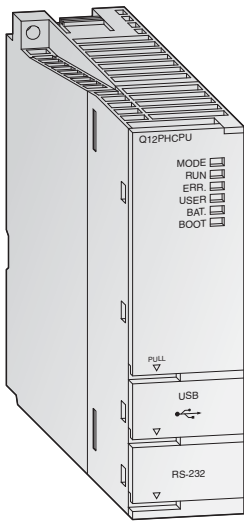

The System Q process CPU allows flexible system design based on off-the-shelf components, which reduces both initial and implementation costs. Using either PX Developer/GX Developer or GX IEC Developer, process applications can be designed, debugged, monitored and maintained. The MELSEC Process Control system is best suited for food manufacturing and chemical plant applications, where liquid or solid materials are stored in a tank and a level must be maintained within a specific range. The Process CPU combines DCS functions with PLC operability into one compact module.

**Special features:**

- Simplified control and engineering
- Extensive Loop control
- High-speed Loop control
- Improved reliability and serviceability
- Hot-swap module replacement in run mode
- Works with CC-Link IE, MELSECNET/H for multiplex remote I/O system
- Loop Control and sequence control with one CPU
- Utilisation and expandability
- Use with isolated analog modules, ideal for process control
- Smoothed analog input value

Specifications	Q02PHCPU	Q06PHCPU	Q12PHCPU	Q25PHCPU
Type	Process CPU module			
I/O points	4096/8192	4096/8192	4096/8192	4096/8192
CPU self-diagnostic functions	CPU error detection, Watch Dog, battery error detection, memory error detection, program check, power supply error detection, fuse error detection			
Multiprocessor mode	Up to 4 CPU modules can be used in combination on one base unit.			
Battery buffer	All CPU modules are fitted with a lithium-battery with a life expectancy of 5 years.			
Memory type	RAM, ROM, FLASH			
Memory capacity	Overall	≤ 32 MByte	≤ 32 MByte	≤ 32 MByte
	Max. for PLC program	28 k steps (112 kByte)	60 k steps (240 kByte)	124 k steps (496 kByte)
Program cycle period	34 ns/ log. instruction	34 ns/ log. instruction	34 ns/ log. instruction	34 ns/ log. instruction
Timer (T)	2048	2048	2048	2048
Counter (C)	1024	1024	1024	1024
Internal/special relay (M)	8192	8192	8192	8192
Data register/special register (D)	12288	12288	12288	12288
File register (R) ①	65536 / max. 1042432	65536 / max. 1042432	131072 / max. 1042432	131072 / max. 1042432
Interrupt pointer (I)	256	256	256	256
Pointer (P)	4096	4096	4096	4096
Annunciator (F)	2048	2048	2048	2048
Index register (Z)	16	16	16	16
Link relay (B)/link register (W)	8192/8192	8192/8192	8192/8192	8192/8192
Number of connectable extensions	7	7	7	7
Max. number of insertable modules	64	64	64	64
Internal power consumption (5 V DC)	640 mA	640	640	640
Max. compensation time at power failure	ms	Varies according to the type of power unit		
Weight	kg	0.20	0.20	0.20
Dimensions (WxHxD)	mm	27.4x98x89.3	27.4x98x89.3	27.4x98x89.3
<b>Order information</b>	Art. no.	218138	218139	143529
Accessories	Software PX-Developer optional			

① Number depends on memory configuration

■ Redundant PLC CPU Modules

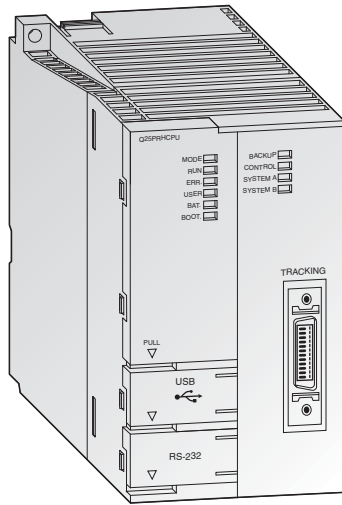

**Redundant PLC CPU Modules**

In a redundant setup two identically-configured systems are automatically kept synchronised to provide “hot standby” functionality, thus guaranteeing maximum availability and failsafe performance. This significantly reduces down time and restart overheads and costs. The higher purchase price of redundant systems are negligible when compared to the costs they can save in the event of a failure.

If the active system fails the hot standby system cuts in automatically and takes over, without any interruption.

The system’s modular architecture makes it possible to implement different levels of redundancy, as required: Power supply redundancy, master redundancy and controller redundancy.

**Special features:**

- QnPRH is based on standard components, so existing peripherals can be used.
- Complete integration in existing and non-redundant environments possible.
- Very short switching times possible – user-configurable, min. switching time 22 ms (48 k words).
- Programmable just like a normal system, using standard software.
- Automatic detection of the active system with MX Components/ MX OPC Server communicating with higher-level systems
- The I/O-level can be connected via MELSECNET/H network (redundant ring), CC-Link, CC-Link IE, Ethernet or Profibus. The availability of these networks can be increased by using redundant master modules.

Specifications	Q12PRH-CPU	Q25PRH-CPU
Type	Process CPU module, high availability	
I/O points	4096/8192	4096/8192
CPU self-diagnostic functions	CPU test, watchdog (time monitoring), battery check, memory test, program plausibility, mains power monitoring, redundancy synchronisation	
Multiprocessor mode	—	
Battery buffer	All CPUs are fitted with a lithium battery with a service life of 5 years.	
Memory type	RAM, ROM, FLASH	RAM, ROM, FLASH
Memory capacity	Overall	≤ 32 MByte
	Max. for PLC program	124 k steps (496 kByte)
Program cycle period	34 ns/log. instruction	34 ns/log. instruction
Timer (T)	2048	2048
Counter (C)	1024	1024
Internal/special relay (M)	8192	8192
Data register/special register (D)	12288	12288
File register (R)	131072 / max. 1042432	131072 / max. 1042432
Interrupt pointer (I)	256	256
Pointer (P)	4096	4096
Annunciator (F)	2048	2048
Index register (Z)	16	16
Link relay (B)/link register (W)	8192/8192	8192/8192
Max. number of insertable modules	Max 11 in main base unit, 64 all via MELSECNET remote connection, no central extension unit can be connected	
Internal power consumption (5 V DC)	mA 640	640
Weight	kg 0.30	0.30
Dimensions (WxHxD)	mm 52.2x98x89.3	52.2x98x89.3
<b>Order information</b>	Art.no. 157070	157071
Accessories	Software PX-Developer (optional)	

\*Tracking cables QC10TR and QC30TR, refer to page 43

**PC CPU Module**

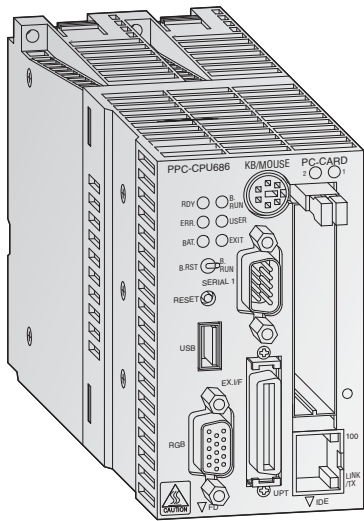

**The personal computer for the base unit**

The PC CPU module is a compact personal computer of high value which can be installed on the main base unit. Here the Q-PC masters PC typical applications as well as PLC applications. Therefore, it is suitable as an integrated PC within control systems - e.g. for visualization, data bases, and log-trace functions of the Microsoft application or for programming the System Q in a high-level language. In addition, the system can be controlled as soft PLC according to IEC 1131 via the optional SX-Controller software. For the connection to the peripherals I/O and special function modules from the MELSEC System Q can be used.

**Special features:**

- Employing with low power consumption and high speed Intel CPU (600 MHz), enabling processing of a large amount of data at high speed
- Windows 2000 operating system supported (XP version also possible on request)
- Capable of connecting silicon disk units for use in a place subject to vibration and shock
- Outstanding noise immunity
- Fan-less operation and suitable for clean-room applications
- Control of a complete system in a high-level language such as C++ or Visual Basic supported

Specifications		PPC-CPU 852(MS)-512	
Type		Personal Computer CPU	
CPU		Ultra low voltage Intel® Celeron® M processor (FSB 400 MHz)	
Processing frequency	MHz	600	
Memory		512 MB (main)/2 x 32 kB L1 (cache), 1 x 512 kB L22 (cache)	
Video		Integrated graphics board for a maximum resolution of 1280 x 1024 pixels, 16 mio. colours	
Interfaces	Serial (RS232C)	2 (1 integrated 9-pin D-SUB connector and 1 optional interface at the extension box which is connected to "EX I/F")	
	Parallel	1	
	USB	4 (3 integrated 9-pin D-SUB connector and 1 optional interface at the extension box which is connected to "EX I/F")	
	Keyboard/mouse	1 x PS/2 connector (keyboard and mouse can be used at the same time with the conversion cable PPC-YCAB-01.)	
	LAN	1 x ETHERNET interface (100BASE-TX/10BASE-T)	
	Monitor	1 x 15-pin H-DSUB	
Connections for drives		1 x disk drive, 2 x hard disk (silicon hard disks are supported)	
PC card slots		2 PCMCIA, CardBus	
No. of occupied I/O points		4096/8192	
Internal power consumption (5 V DC)	mA	3000	
Weight	kg	0.47	
Dimensions (WxHxD)	mm	55.2x98x115	
Order information	PPC-SET-Nil	art. no.: 207875	set with 1 x PC CPU module; 512 MB RAM, no hard disk, driver PPC-DRV-02, without operating system
	PPC-SET-Win 2000	art. no.: 207876	set with 1 x PC CPU module; 512 MB RAM, 20 GB hard disk, driver PPC-DRV-02, operating system Windows 2000
	PPC-SET-WinXp pro	art. no.: 207877	set with 1 x PC CPU module; 512 MB RAM, 20 GB hard disk, driver PPC-DRV-02, operating system Windows XP pro
	PPC-SET-WinXp Imb	art. no.: 207878	set with 1 x PC CPU module; 512 MB RAM, 20 GB hard disk, driver PPC-DRV-02, operating system Windows XP Imb
Accessories		Additional hard disks, external drives, cables etc. (refer to pages 50–55); Soft PLC for the Q PC CPU: SX-Controller for Windows NT/2000 without realtime environment (SX-Controller V0100-1LOC-E, art. no.: 144006)	



**C-Controller CPU**

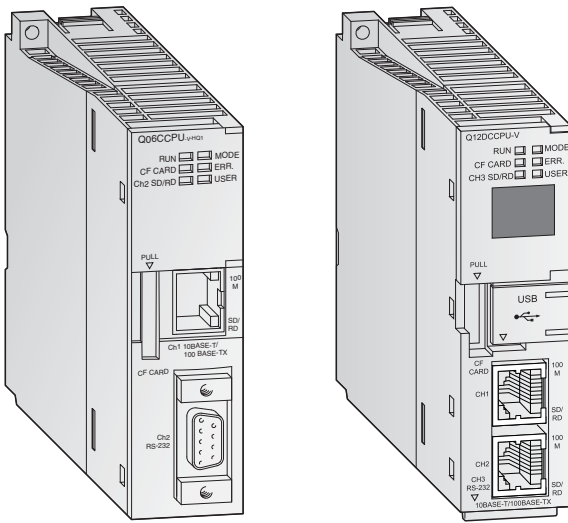

**High-level language programming in combination with real time operating system**

The C-Controller allow the integration and programming of the automation platform System Q with C++. Using the worldwide established real time operating system VxWorks, realisation of complex tasks, communication and protocols becomes easy.

**Special features:**

- Integration in the multi CPU layout of System Q through combination with PLC and Motion CPUs or use as stand-alone system.
- Real time operating system VxWorks
- Dedicated development environment of C-/C++ language
- Compact Flash card makes handling of large quantities of data easy
- High performance addition to the existing range of automation products
- 7-segment LED display for efficient debugging and trouble-shooting (Q12CCPU-V only)
- Ethernet and RS-232 interface on board
- Q12DCCPU-V with additional USB interface
- Real time OS VxWorks and Telnet pre-installed
- Standard C/C++ Code can be embedded
- Remote access via networks und support of FTP
- VxWorks communication library and QBF libraries for easy setup
- CoDeSys compatibility

Specifications	Q06CCPU-V-H01	Q12DCCPU-V
Number of I/Os	4096 (X/Y0–X/YFFF)	
Memory	Standard ROM: 16 MB (user area: 6 MB); Work RAM: 32 MB (user area: 14 MB); Battery-backed-up RAM: 128 kB	Standard RAM: 3 MB; Work RAM: 128 MB; Battery-backed-up RAM: 128 kB
Operating system	VxWorks Version 5.4 (preinstalled)	VxWorks Version 6.4 (preinstalled)
Programming language	C or CC++	
Development tool	Tornado 2.1 (licenses with special conditions for Mitsubishi users are available directly from Wind River)	Workbench 2.6.1
Communication interfaces	RS232 (1 ch.), 10BASE-T/100BASE-TX (1 ch.)	RS232 (1 ch.), 10BASE-T/100BASE-TX (2 ch.), USB (1 ch.)
Data format	1 start bit, 7 or 8 data bits, 1 or 0 parity bits, 1 or 2 stop bits	
Parity check	Parity checking can be activated by the user	
Checksum	Checksum can be activated by the user	
Data communications control	By control of the RS and CS signals (user-configurable)	
Connection of external wiring	9-pin SubD (RS-232), RJ45 (Ethernet)	
CF card I/F	1 slot for a TYPE I card (Max. 1 GB CF card is supported)	1 slot for a TYPE I card (Max. 8 GB CF card is supported)
Integrated clock	Year, month, day, minute, second, weekday (automatic leap year adjustment)	
Max. compensation time at power failure	Depends on power supply	
Internal power consumption (5 V DC)	A 0.71	0.93
Weight	kg 0.17	0.24
Dimensions (WxHxD)	mm 27.4x98x89.3	27.4x98x115
<b>Order information</b>	Art. no. 165353	221925
Accessories	Programming via Ethernet, cross-link cable (X-Link) may be required. Programming software C-Controller Configurator V0100-1LOC-E; art. no. 165367 A special development suite (Tornado, WindView, Sniff+) for the Q06CCPU is available worldwide from any Wind River branch, just quote our contract no. 209356. A free demo version is available for testing. The development tool Workbench 2.6.1 is available from Wind River Systems.	

**Motion CPU Modules**

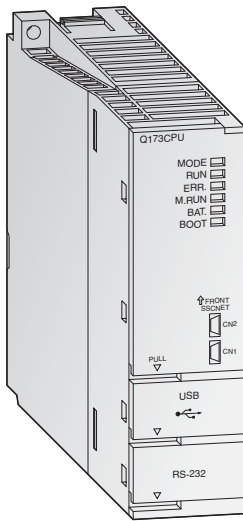

**The high-speed dynamic motion CPU**

The motion controller CPU controls and synchronizes the connected servo amplifiers and servo motors. A motion system besides the controller CPU as well includes a PLC CPU. Only after combining a highly dynamic positioning control and a PLC an innovative and autarkical motion control system is created.

While the Motion CPU controls large-scale servo movements the PLC CPU is responsible for the machine control and the communication at the same time.

**Special features:**

- Using multiple CPUs to distribute the load improves the overall performance of the whole system
- Use of up to 3 motion CPUs within one system
- Large scale control system for up to 96 axes per system
- Interpolation of 4 axes simultaneously
- Software cam control
- Virtual and real master axes
- Integration in the high-speed SSCNET III network for communication with high-performance servo amplifiers at up to 5.6 Mbit/s

Specifications	Q172CPUN	Q172DCPU	Q172HCPU	Q173CPUN	Q173DCPU	Q173HCPU	
Type	Motion CPU	Motion-CPU	Motion-CPU	Motion CPU	Motion-CPU	Motion-CPU	
I/O points	8192	8192	8192	8192	8192	8192	
No. of control axes	8	8	8	32	32	32	
Interpolation functions	Linear interpolation for up to 4 axes, circular interpolation for 2 axes, helical interpolation for 3 axes						
Positioning	Method	PTP (point to point), speed control/speed-position control, fixed pitch feed, constant speed control, position follow-up control, speed switching control, high-speed oscillation control, synchronous control (SV22)					
	Acceleration/ deceleration control	Automatic trapezoidal acceleration/deceleration, S-curve acceleration/deceleration					
	Compensation	Backlash compensation, electronic gear					
Programming language	Motion SFC, dedicated instructions, software for conveyor assembly (SV13), virtual mechanical support language (SV22)						
Processing speed	SV13	0.88 ms (1.–8. axis)	0.44 ms (1.–6. axis), 0.88 ms (7.–8. axis)	0.44 ms (1.–3. axis), 0.88 ms (1.–8. axis)	0.88 ms (1.–8. axis), 1.77 ms (9.–16. axis), 3.55 ms (17.–32. axis)	0.88 ms (1.–6. axis), 1.77 ms (7.–18. axis), 3.55 ms (19.–32. axis)	0.44 ms (1.–3. axis), 0.88 ms (4.–10. axis), 1.77 ms (11.–28. axis), 3.55 ms (21.–32. axis)
	SV22	0.88 ms (1.–4. axis), 1.77 ms (5.–8. axis)	0.44 ms (1.–4. axis), 0.88 ms (5.–8. axis)	0.88 ms (1.–4. axis), 1.77 ms (5.–8. axis)	0.88 ms (1.–4. axis), 1.77 ms (5.–12. axis), 3.55 ms (13.–24. axis), 7.11 ms (25.–32. axis)	0.44 ms (1.–4. axis), 0.88 ms (5.–12. axis), 1.77 ms (13.–28. axis), 3.55 ms (29.–32. axis)	0.88 ms (1.–5. axis), 1.77 ms (6.–14. axis), 3.55 ms (15.–28. axis), 7.11 ms (29.–32. axis)
Program capacity	14 k steps						
No. of positioning points	3200						
Program execution	Number of multi executed programs	Max. 256					
	Number of multi active steps	Max. 256 steps in all programs					
	Executed tasks	normal	Executed in motion main cycle				
		interrupt	Executed in fixed cycles (0.88 ms, 1.7 ms, 3.5 ms, 7.1 ms, 14.2 ms) 16 external interrupt points (QI60 interrupt module inputs), executed with interrupt from PLC CPU (when executing the S(P), GINT instruction)				
NMI	16 points; executed when input ON is set among an interrupt module (e.g. QI60)						
Interfaces	USB, RS232C, SSCNET	SSCNETIII (USB, RS-232C via PLC CPU)	USB, RS232C, SSCNET	USB, RS232C, SSCNET	SSCNETIII (USB, RS-232C via PLC CPU)	USB, RS232C, SSCNET	
Real I/O points (PX/PY)	256 (these I/Os can be allocated directly to the motion CPU)						
Certifications	—	CE, UL & cUL	CE, UL & cUL	—	CE, UL & cUL	CE, UL & cUL	
Internal power consumption (5 VDC)	A	1.62	1.14	1.75	1.25	1.25	
Weight	kg	0.25	0.33	0.25	0.33	0.23	
Dimensions (W x H x D)	mm	27.4x98x114.3	27.4x98x119.3	27.4x98x114.3	27.4x98x114.3	27.4x98x114.3	
<b>Order information</b>	Art. no.	142695	209788	162417	142696	209787	162696
Accessories	Interface modules for manual pulse generator, encoder and external signals (for detailed informations please refer to the catalogue "Motion Controller System Q".)						

## ■ Safety CPU Module

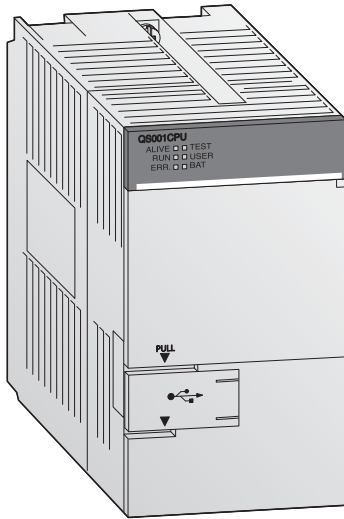

### Safety control with QS Safety PLC

The CC-Link Safety network eliminates the complex wiring needed in conventional safety controller systems. The remote Safety I/O stations are connected to the CC-Link Safety master module in the Safety PLC using standard CC-Link cables. In the event of communications errors powerful and effective error identification routines automatically switch off the outputs of both the Safety PLC and the remote Safety I/O stations.

CC-Link Safety is also compatible with CC-Link. This means you can also use standard CC-Link I/O modules in a CC-Link Safety network for those inputs and outputs that are not critical for safety.

### Special features:

- Conforms to the safety requirements of EN954-1 Category 4, ISO13849-1 PL e, and IEC61508 (JIS C 0508) SIL 3 and certified by TÜV Rheinland
- Automatic checking of safety inputs and outputs and external devices (cable breaks, short circuits, fused contactor contacts etc.)
- Program and configure with the familiar GX Developer programming software packages. No new skills or software are required.
- Reduced wiring requirements cuts costs
- Comprehensive diagnostics functions
- Versatile: A single Safety CPU can control up to 84 remote safety stations
- The CC-Link standard enables connection of third-party products compatible with the safety concept

Specifications	QS001CPU
I/O points	4096/8192
Control method	Cyclic program execution
Programming language (Sequence Control)	Relay symbol language, function block
Processing speed	0.10–0.35 $\mu$ s
Constant scan	1–2,000 ms (setting unit: 1 ms)
Program capacity	14 k steps (56 kB)
Memory capacity	128 kB
Max. number of stored files	3
Internal relay (M)	6144
Link relay (B)	2048
Timer (T)	512
Counter (C)	512
Data register (D)	6144
Link register (W)	2048
Annunciator (F)	1024
RUN/PAUSE contact	RUN contact: 1 point can be set in the range of X0 to 17FF, PAUSE contact: None
Clock function	Year, month, date, hour, minute, second, day (automatic leap-year detection)
Internal power consumption (5 V DC)	A 0.43
Weight	kg 0.29
Dimensions (WxHxD)	mm 55.2x98x113.8
<b>Order information</b>	Art. no. 203205

**Digital Input Modules**

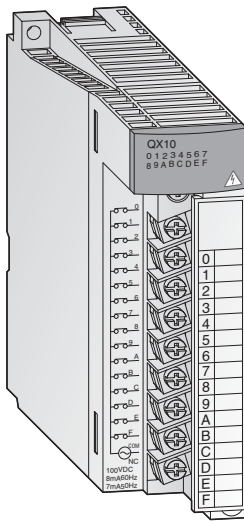

**Detection of process signals**

Various input modules are available for converting the digital process signals with different voltage levels into the levels required by the PLC.

**Special features:**

- Potential isolation between process and control by means of an optocoupler is a standard feature.
- Indication of input status via LEDs
- Modules with 16 connection points have removable terminal blocks with screws.
- Assembled cables are available for modules with plugs.
- Different system terminals for module wiring simplification are available.

Specifications		QX10	QX10-TS	QX28	QX40	QX40-TS	QX41	QX42
Input points		16	16	8	16	16	32	64
Insulation method		Photocoupler insulation between input terminals and PC power for all modules.						
Rated input voltage		100–120 V AC (50/60 Hz)	100–120 V AC (50/60 Hz)	100–240 V AC (50/60 Hz)	24 V DC	24 V DC	24 V DC	24 V DC
Operating voltage range		V 85–132	85–132	85–264	20.4–28.8	20.4–28.8	20.4–28.8	20.4–28.8
Max. simultaneously ON (at rated voltage)		100 % ②	100 % ②	100 %	100 % (sink type)	100 % (sink type)	100 % (sink type)	100 % ② (sink type)
Inrush current		200 mA for 1 ms (at 132 V AC)	200 mA for 1 ms (at 132 V AC)	200 mA for 1 ms (at 132 V AC)	—	—	—	—
Rated input current		mA 7 (100 V AC, 50 Hz), 8 (100 V AC, 60 Hz)	8 (100 V AC, 60 Hz), 7 (100 V AC, 50 Hz)	7 (100 V AC, 50 Hz), 8 (100 V AC, 60 Hz), 14 (200 V AC, 50 Hz), 17 (200 V AC, 60 Hz)	approx. 4	approx. 4	approx. 4	approx. 4
ON	Voltage	V ≥ AC 80	≥ AC 80	≥ AC 80	≥ DC 19	≥ DC 19	≥ DC 19	≥ DC 19
	Current	mA ≥ AC 5	≥ AC 5	≥ AC 5	≥ DC 3	≥ DC 3	≥ DC 3	≥ DC 3
OFF	Voltage	V ≤ AC 30	≤ AC 30	≤ AC 30	≤ DC 11	≤ DC 11	≤ DC 11	≥ DC 11
	Current	mA ≤ AC 1	≤ AC 1.7	≤ AC 1	≤ DC 1.7	≤ DC 1.7	≤ DC 1.7	≥ DC 1.7
Load resistance		kΩ Approx. 18 (50 Hz) Approx. 15 (60 Hz)	approx. 12 (60 Hz) approx. 15 (50 Hz)	approx. 15 (50 Hz) approx. 12 (60 Hz)	approx. 5.6	—	approx. 5.6	approx. 5.6
Response time	OFF → ON	ms ≤ 15 (100 V AC, 50/60 Hz)	≤ 15 (100 V AC, 50/60 Hz)	≤ 15 (100 V AC, 50/60 Hz)	1–70 ①	1–70 ①	1–70 ①	1–70 ①
	ON → OFF	ms ≤ 20 (100 V AC, 50/60 Hz)	≤ 20 (100 V AC, 50/60 Hz)	≤ 20 (100 V AC, 50/60 Hz)	1–70 ①	1–70 ①	1–70 ①	1–70 ①
Common terminal arrangement		16	16	8	16	16	32	32
Power indicator		All modules possess a status LED per input/output.						
Connection terminal		18-point removable terminal block with screws	Removable terminal block with spring terminals	18-point removable terminal block with screws	18-point removable terminal block with screws	Removable terminal block with spring terminals	40-pin connector	Two 40-pin connectors
No. of occupied I/O points		16	16	16	16	16	32	64
Applicable wire size		mm <sup>2</sup> 0.3–0.75	0.3–0.75	0.3–0.75	0.3–0.75	0.3–0.75	0.3	0.3
Internal power consumption (5 V DC)		mA 50 (all input points ON)	50 (all input points ON)	50 (all input points ON)	50 (all input points ON)	50 (all input points ON)	75 (all input points ON)	90 (all input points ON)
Weight		kg 0.17	0.17	0.20	0.16	0.16	0.15	0.18
Dimensions (WxHxD)		mm 27.4x98x90	27.4x98x90	27.4x98x90	27.4x98x90	27.4x98x90	27.4x98x90	27.4x98x90
Order information		Art. no. 129581	221838	136396	132572	221839	132573	132574
Accessories		40-pin connector and ready to use connection cables (refer to page 50–52); Spring clamp terminal block for exchange against the standard screw terminal block (refer to page 54)						

① CPU parameter setting (default setting: 10 ms) ② at 45 °C

**Digital Input Modules**

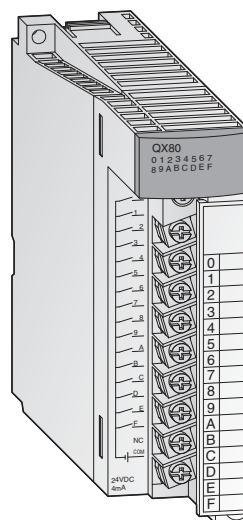
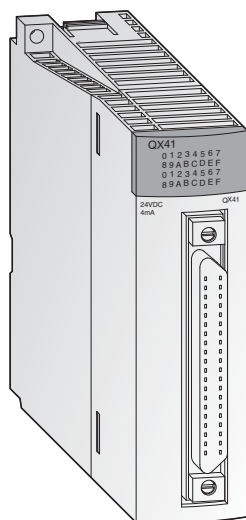

Specifications	QX50	QX80	QX80-TS	QX81	QX82-S1
Input points	16	16	16	32	64
Insulation method	Photocoupler insulation between input terminals and PC power for all modules.				
Rated input voltage	48 V DC	24 V DC	24 V DC	24 V DC	24 V DC
Operating voltage range	V 40.8–52.8	20.4–28.8	20.4–28.8	20.4–28.8	20.4–28.8
Max. simultaneously ON (at rated voltage)	100 %	100 %	100 %	100 %	100 % ②
Inrush current	—	—	—	—	—
Rated input current	mA Approx. 4	approx. 4	approx. 4	approx. 4	approx. 4
ON	Voltage	V ≥ DC 28	≥ DC 19	≥ DC 19	≥ DC 19
	Current	mA ≥ DC 2.5	≥ DC 3	≥ DC 3	≥ DC 3
OFF	Voltage	V ≤ DC 10	≤ DC 11	≤ DC 11	≤ DC 9.5
	Current	mA ≤ DC 1.7	≤ DC 1.7	≤ DC 1.7	≤ DC 1.5
Load resistance	kΩ Approx. 11.2	approx. 5.6	approx. 5.6	approx. 5.6	approx. 5.6
Response time	ms OFF → ON	1–70 ①	1–70 ①	1–70 ①	0.1–1 ①
	ms ON → OFF	1–70 ①	1–70 ①	1–70 ①	0.1–1 ①
Common terminal arrangement	16	16	16	32	32 x 2
Power indicator	All modules with 16 and 32 inputs possess a status LED per input. For modules with 64 inputs the indication is switchable.				
Connection terminal	18-point removable terminal block with screws	18-point removable terminal block with screws	Removable terminal block with spring terminals	Compact connector 37-pin D-Sub	40-pin connector x 2
No. of occupied I/O points	16	16	16	32	64
Applicable wire size	mm <sup>2</sup> 0.3	0.3–0.75	0.3–0.75	0.3	0.3
Internal power consumption (5 V DC)	mA 50 (all input points ON)	50 (all input points ON)	50 (all input points ON)	75 (all input points ON)	90 (all input points ON)
Weight	kg 0.13	0.16	0.16	0.16	0.18
Dimensions (WxHxD)	mm 27.4x98x90	27.4x98x90	27.4x98x90	27.4x98x90	27.4x98x90
<b>Order information</b>	Art. no. 204678	127587	221840	129594	150837
Accessories	40-pin connector and ready to use connection cables (refer to page 50–52); Spring clamp terminal block for exchange against the standard screw terminal block (refer to page 54)				

① CPU parameter setting (default setting: 10 ms) ② at 45 °C



**Digital Output Modules**

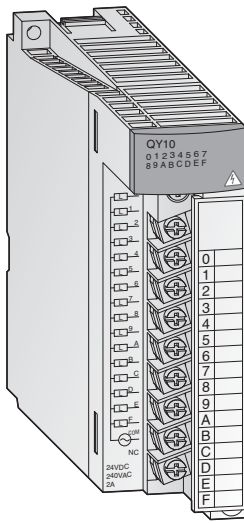

**Adapted output technology**

The MELSEC System Q output modules have different switching elements for adaptation to many control tasks.

**Special features:**

- Output modules with relay, transistor or triac switches
- Potential isolation between process and control by means of an optocoupler is a standard feature
- Modules with potential isolation between the channels
- Modules with 16 protection points have removable terminal blocks with screws
- Assembled cables are available for modules with D-sub plugs (Q32CBL: 3 m or 5 m; Q40CBL: 3 m or 5 m).
- Different system terminals for simplified cabling and to supplement the performance of the modules are available.

Specifications	QY10	QY10-TS	QY18A	QY22	QY40P	QY40P-TS	QY41P	QY42P	
Outputs	16	16	8	16	16	16	32	64	
Output type	Relay	Relay	Relay	Triac	Transistor (sink type)	Transistor (sink type)	Transistor (sink type)	Transistor (sink type)	
Common terminal arrangement	points	16	16	8	16	16	32	32	
Insulation method	Relay	Relay	Relay	Photocoupler insulation between output terminals and PC power					
Rated output voltage	24 V DC/240 V AC	24 V DC/240 V AC	24 V DC/240 V AC	100–240 V AC	12/24 V DC (sink type)	12/24 V DC (sink type)	12/24 V DC (sink type)	12/24 V DC (sink type)	
Operating voltage range	—	—	—	—	10.2–28.8 V DC	10.2–28.8 V DC	10.2–28.8 V DC	10.2–28.8 V DC	
Min. switching load	5 V DC (1 mA)	5 V DC (1 mA)	5 V DC (1 mA)	24 V AC (100 mA) 100 V AC (25 mA) 240 V AC (25 mA)	—	—	—	—	
Max. switching voltage	125 V DC/264 V AC	125 V DC/264 V AC	125 V DC/264 V AC	288 V AC	—	—	—	—	
Max. output current	A	2	2	0.6	0.1	0.1	0.1	0.1	
Output current per group TYP	A	8	8	4.8	1.6	1.6	2	2	
Inrush current	ms	—	—	—	0.7 for 10	0.7 for 10	0.7 for 10	0.7 for 10	
Leakage current at OFF	mA	—	—	—	≤ 0.1	≤ 0.1	≤ 0.1	≤ 0.1	
Response time	OFF → ON	ms	≤ 10	≤ 10	≤ 10	1	≤ 1	≤ 1	≤ 1
	ON → OFF	ms	≤ 12	≤ 12	≤ 12	1	≤ 1	≤ 1	≤ 1
Life	Mechanical	Switching 20 million times			—	—	—	—	
	Electrical	Switching 100000 times or more			—	—	—	—	
Max. switching frequency	Switching 3600 times/h			—	—	—	—		
Noise suppression	—	—	—	RC-	Zener diode	Zener diode	—	—	
Fuse	A	—	—	—	—	—	short-circuit proof	short-circuit proof	
Power indicator	All modules possess a status LED per output.								
Fuse blown indicator	—	—	—	—	—	—	—	—	
Connection terminal	18-point removable terminal block with screws	Removable terminal block with spring terminals	18-point removable terminal block with screws	18-point removable terminal block with screws	18-point removable terminal block with screws	Removable terminal block with spring terminals	40-pin connector	40-pin connector x 2	
No. of occupied I/O points	16	16	16	16	16	16	32	64	
Applicable wire size	mm <sup>2</sup>	0.3–0.75	0.3–0.75	0.3–0.75	0.3–0.75	0.3–0.75	0.3	0.3	
Ext. power supply req.	Voltage	—	—	—	12–24 V DC	12–24 V DC	12–24 V DC	12–24 V DC	
	Current	mA	—	—	—	10 (24 V DC)	10 (24 V DC)	20 (24 V DC)	20 (24 V DC)
Internal power consumption (5 V DC)	mA	430	430	430	250	65	65	105	
Weight	kg	0.22	0.22	0.22	0.40	0.16	0.16	0.15	
Dimensions (WxHxD)	mm	27.4x98x90	27.4x98x90	27.4x98x90	27.4x98x90	27.4x98x90	27.4x98x90	27.4x98x90	
<b>Order information</b>	Art. no.	129605	221841	136401	136402	132575	221842	132576	132577
Accessories	40-pin connector and ready to use connection cables (refer to page 50–52); Spring clamp terminal block for exchange against the standard screw terminal block (refer to page 54);								

## Digital Output Modules

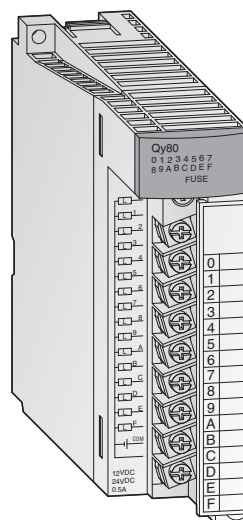
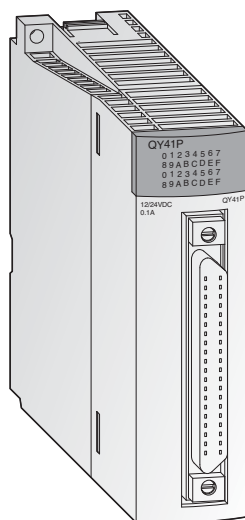

2

DIGITAL MODULES

Specifications	QY50	QY68A	QY80	QY80-TS	QY81P	
Outputs	16	8	16	16	32	
Output type	Transistor (sink type)	Transistor (sink/source type)	Transistor (source type)	Transistor (source type)	Transistor (source type)	
Common terminal arrangement	points	8	16	16	32	
Insulation method	Photocoupler insulation between output terminals and PC power					
Rated output voltage	12/24 V DC (sink type)	5–24 V DC	12/24 V DC (source type)	12/24 V DC (source type)	12/24 V DC (source type)	
Operating voltage range	10.2–28.8 V DC	4.5–28.8 V DC	10.2–28.8 V DC	10.2–28.8 V DC	10.2–28.8 V DC	
Min. switching load	—	—	—	—	—	
Max. switching voltage	—	—	—	—	—	
Max. output current	A	0.5	2	0.5	0.1	
Output current per group TYP	A	4	—	4	2	
Inrush current	0.7 for 10 ms	8 A for 10 ms	4 A for ≤ 10 ms	4 A for ≤ 10 ms	0.7 A for ≤ 10 ms	
Leakage current at OFF	mA	≤ 0.1 mA	≤ 0.1	≤ 0.1	≤ 0.1	
Response time	OFF → ON	ms	≤ 1	≤ 3	1	1
	ON → OFF	ms	≤ 1	≤ 10	1	1
Life	Mechanical	—	—	—	—	—
	Electrical	—	—	—	—	—
Max. switching frequency	—	—	—	—	—	
Noise suppression	Zener diode	Zener diode	Zener diode	Zener diode	Zener diode	
Fuse	A	6.7	—	4 A (2 pices)	4 A (2 pices)	short-circuit proof
Power indicator	All modules possess a status LED per output.					
Fuse blown indicator	LED	—	LED	LED	LED	
Connection terminal	18-point removable terminal block with screws	18-point removable terminal block with screws	18-point removable terminal block with screws	Removable terminal block with spring terminals	Compact connector 37-pin D-Sub	
No. of occupied I/O points	16	16	16	16	32	
Applicable wire size	mm <sup>2</sup>	0.3–0.75	0.3–0.75	0.3–0.75	0.3	
Ext. power supply req.	Voltage	12–24 V DC	—	12–24 V DC	12–24 V DC	12–24 V DC
	Current	mA	20 (24 V DC)	—	20 (24 V DC)	20 (24 V DC)
Internal power consumption (5 V DC)	mA	80	110	80	80	95
Weight	kg	0.17	0.14	0.17	0.17	0.15
Dimensions (WxHxD)	mm	27.4x98x90	27.4x98x90	27.4x98x90	27.4x98x90	27.4x98x90
<b>Order information</b>	Art. no.	132578	136403	127588	221843	129607
Accessories	40-pin connector and ready to use connection cables (refer to page 50–52); Spring clamp terminal block for exchange against the standard screw terminal block (refer to page 54)					

■ Analog Input Modules

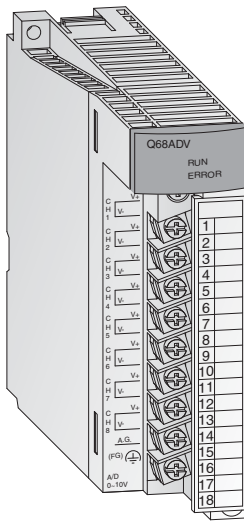

**Detection of analog process signals**

The analog input modules convert analog process signals, for example pressure, flow or fill level, linearly into digital values, which are further processed by the Q CPU.

**Special features:**

- Up to 8 channels per module (Q68AD□) and up to 256 channels per system (Q CPU)
- Resolution of 0.83 mV and 3.33 μA (Q64AD)
- Conversion time of 80 μs/channel (Q68AD□)
- Calculation of average value over the time or measurement cycles can be configured
- Potential isolation between process and control by means of an optocoupler is a standard feature.
- All modules are provided with a removable terminal block fastened with screws.

Specifications		Q64AD	Q68ADV	Q68ADI
Input points		4	8	8
Analog input		-10 V/+10 V (0 mA/+20 mA)	-10 V/+10 V	0 mA/+20 mA
Resolution		16 bits binary (incl. sign)	16 bits binary (incl. sign)	16 bits binary (incl. sign)
Load resistance	Voltage	MΩ 1	1	1
	Current	Ω 250	250	250
Max. input	Voltage	V ±15	±15	±15
	Current	mA ±30	±30	±30
I/O characteristics <sup>①</sup>	Analog input	-10—+10 V	0—20 mA	-10—+10 V
	Digital output	1/4000, 1/12000, 1/16000	1/4000, 1/8000, 1/12000	1/4000, 1/12000, 1/16000
Max. resolution	Voltage input	2.5 mV 1.25 mV 0.83 mV	—	2.5 mV 5 mV 1.25 mV 1 mV
	Current input	—	10 μA 5 μA 3.33 μA	—
Overall accuracy		±0.4 % (0–55 °C), ±0.1 % (20–30 °C)	±0.4 % (0–55 °C), ±0.1 % (20–30 °C)	—
Max. conversion time		80 μs/channel (+ 160 μs with temperature drift compensation)	80 μs/channel (+ 160 μs with temperature drift compensation)	—
Insulation method		Photocoupler insulation between output terminals and PC power for all modules.	Photocoupler insulation between output terminals and PC power for all modules.	—
I/O points		16	16	16
Connection terminal		All modules are fitted with a terminal block with 18 screw terminals.	All modules are fitted with a terminal block with 18 screw terminals.	—
External power consumption		Not necessary	Not necessary for any module	—
Applicable wire size		mm <sup>2</sup> 0.3–0.75	0.3–0.75	0.3–0.75
Internal power consumption (5 V DC)		mA 630	640	640
Weight		kg 0.14	0.19	0.19
Dimensions (WxHxD)		mm 27.4x98x90	27.4x98x90	27.4x98x90
Order information		Art. no. 129615	129616	129617

① ±0.4 % (0–55 °C), ±0.1 % (20–30 °C)

■ Analog Input Modules

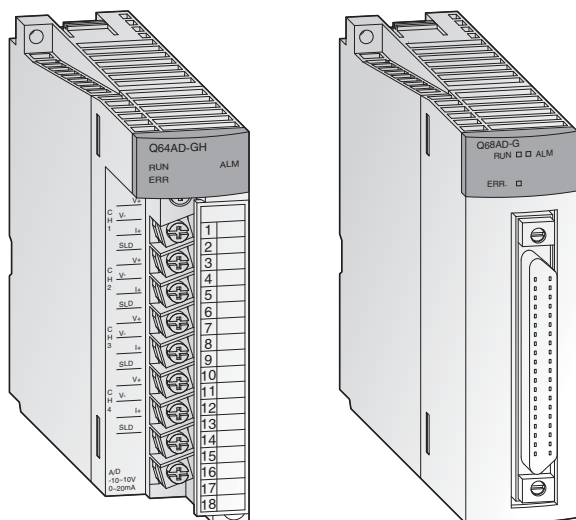

Channel isolated and high resolution

The analog input modules convert analog process signals into digital values with high accuracy. With the exception of the ME1AD8HAI-Q, all channels are isolated between each other and against the external power supply with high dielectric withstand voltage for both.

The ME1AD8HAI-Q provides a HART master function and can communicate with up to eight HART-enabled devices. The connection of standard analog input devices is also supported.

Special features:

- Potential isolation between each channel and between process and control is a standard feature.
- High resolution: 16/32 bit signed binary
- High accuracy with a reference accuracy of ±0.05 % and a temperature coefficient of ±71.4 ppm/°C
- Integrated short circuit protection by limiting the input current
- Signal conditioning function for the Q62AD-DGH
- Q66AD-DG signal converter
- Power supply for 2-wire transmitter (Q66AD-GD, ME1AD8HAI-Q)
- A primary delay filter smoothes out the line of digital output values by a user-defined time constant
- Terminal block is fastened with screws and removable.

Specifications	Q62AD-DGH	Q64AD-GH	Q66AD-DG	Q68AD-G	ME1AD8HAI-Q	
Input points	2	4	6	8	8	
Analog input	+4 mA/+20 mA	-10 V/+10 V (0 mA/+20 mA)	0 mA/+4 mA/20 mA	-10 V/+10 V (0 mA/+20 mA)	0 mA/+4 mA/+20 mA	
Resolution	16/32 bits binary (incl. sign)	16/32 bits binary (incl. sign)	16 bits binary (incl. sign)	16 bits binary (incl. sign)	16 bits signed binary	
Load resistance	Voltage	—	1	—	1	
	Current	250	250	250	250	
Max. input	Voltage	±15	±15	—	±15	
	Current	±30	±30	±30	±30	
I/O characteristics	Analog input	4–20 mA	-10–+10 V	0–20 mA	-10–+10 V; 0–20 mA	0–20 mA; 4–20 mA
	Digital output	0–32000 (16 bits) 0–64000 (32 bits)	-32000–+32000 (16 bits), -64000–+64000 (32 bits), 0–32000 (16 bits), 0–64000 (32 bits)	-96–+4095 (16 bits), -288–+12287 (16 bits)	-12288–+12287 (16 bits), -16384–+16383 (16 bits), -32768–+32767 (16 bits)	0–32000 (16 bits, 32 bits)
Max. resolution	Voltage input	—	0–10 V: 156.3 μV (32 bits), 312.6 μV (16 bits), 0–5 V: 78.2 μV (32 bits), 156.4 μV (16 bits), 1–5 V: 62.5 μV (32 bits), 125.0 μV (16 bits), -10–10 V: 156.3 μV (32 bits), 312.6 μV (16 bits)	—	0–10 V: 0.625 mV (16 bits), 0–5 V: 0.416 mV (16 bits), 1–5 V: 0.333 mV (16 bits), -10–10 V: 0.625 mV (16 bits), user defined: 0.333mV (16 bits)	—
	Current input	4–20 mA: 0.25 μA (32 bits), 0.50 μA (16 bits) user defined: 0.151 μA (32 bits), 0.303 μA (16 bits)	0–20 mA: 0.312 μA (32 bits), 0.625 μA (16 bits) 4–20 mA: 0.25 μA (32 bits), 0.50 μA (16 bits) user defined: 0.151 μA (32 bits), 0.303 μA (16 bits)	0–20 mA: 1.66 μA (16 bits) 4–20 mA: 1.33 μA (16 bits) user defined: 1.33 μA (16 bits)	0–20 mA: 1.66 μA (16 bits) 4–20 mA: 1.33 μA (16 bits) user defined: 1.33 μA (16 bits)	0–20 mA: 0.625 μA 4–20 mA: 0.50 μA
Overall accuracy	±0.05 %	±0.05 %	±0.1 %	±0.1 %	±0.15 %	
Temperature coefficient	±71.4 ppm/°C (0.00714 %/°C)	±71.4 ppm/°C (0.00714 %/°C)	±71.4 ppm/°C (0.00714 %/°C)	±71.4 ppm/°C (0.00714 %/°C)	—	
Max. conversion time	10 ms/2 channels	10 ms/4 channels	10 ms/channel	10 ms/channel	80 ms (channel independent)	
Insulation method	Photocoupler insulation between each channel	Photocoupler insulation between each channel	Transformer insulation between the input channels and between the channels and PLC power	Transformer insulation between the input channels and between the channels and PLC power	Photocoupler insulation between the channels and OLC power; No insulation between analog input channels	
I/O points	16	16	16	16	32	
Connection terminal	Removable terminal block with 18 screw terminals	Removable terminal block with 18 screw terminals	40-pin connector at the front	40-pin connector at the front	Removable terminal block with 18 screw terminals	
External power consumption	24 V DC, 360 mA	Not necessary	24 V DC, 360 mA	Not necessary	24 V DC, 300 mA	
Applicable wire size	mm <sup>2</sup> 0.3–0.75	0.3–0.75	0.3	0.3	0.51	
Internal power consumption (5 V DC)	220	890	420	460	320	
Weight	kg 0.19	0.20	0.22	0.16	0.19	
Dimensions (WxHxD)	mm 27.4x98x90	27.4x98x90	27.4x102x130	27.4x102x90	27.4x98x90	
Order information	Art. no. 145036	143542	204676	204675	229238	

■ Analog Output Modules

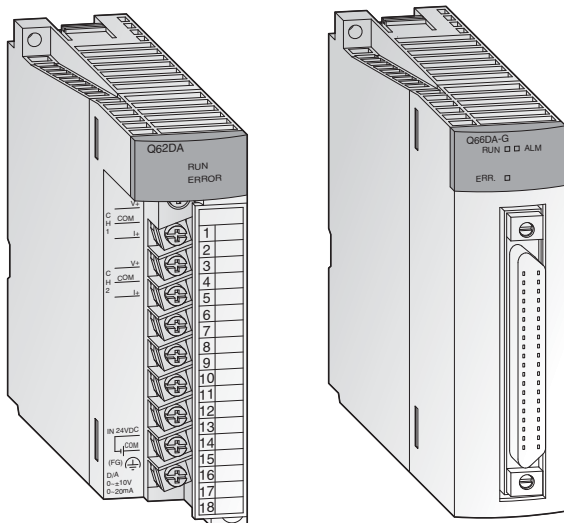

Output of analog control signals

The analog output modules convert digital values predetermined by the CPU into an analog current or voltage signal. For example, frequency inverters, valves or slide valves are controlled by means of these signals.

Special features:

- Up to 8 channels per module (Q68DA□) and up to 256 channels per system
- Resolution of 0.333 mV and 0.83 μA
- Conversion time of 80 μs/channel
- Potential isolation between process and control by means of an optocoupler is a standard feature. Additional potential isolation between the channels for the Q62DANQ, 62DAN-FGQ, 68DAVN and Q68DAIN.
- Disconnection detection function that monitors the output values by means of re-conversion and limit exceeding function (Q62DAN-FG only)
- The modules are provided with a removable terminal block fastened with screws.

Specifications	Q62DAN	Q62DA-FG	Q64DAN	Q66DA-G	Q68DAVN	Q68DAIN			
Output points	2	2	4	6	8	8			
Digital input	-4096—+4095 -12288—+12287 -16384—+16383	-4096—+4095 -12288—+12287 -16384—+16383	-4096—+4095 -12288—+12287 -16384—+16383	-4096—+4095 -12288—+12287 -16384—+16383	-4096—+4095 -12288—+12287 -16384—+16383	-4096—+4095 -12288—+12287 -16384—+16383			
Analog output	-10 V DC—+10 V DC (0 mA—+20 mA DC)	-10 V DC—+10 V DC (0 mA—+20 mA DC)	-10 V DC—+10 V DC (0 mA—+20 mA DC)	-12 V DC—+12 V DC (0 mA—+22 mA DC)	-10 V DC—+10 V DC	0 mA—+20 mA DC			
Load resistance	Voltage output	1 kΩ—1 MΩ	1 kΩ—1 MΩ	1 kΩ—1 MΩ	1 kΩ—1 MΩ	—			
	Current output	0—600 Ω	0—600 Ω	0—600 Ω	—	0—600 Ω			
Max. outputs	Voltage	V ±12	±13	±12	±13	—			
	Current	mA 21	23	21	23	—	21		
Voltage output <sup>①</sup>									
I/O characteristics	Voltage output	0—5 V	0—5 V	1—5 V	1—5 V	-10—+10 V	-10—+10 V	user defined	user defined
	Digital input	0—4000	0—12000	0—4000	0—12000	-4000—4000	-16000—16000	-4000—4000	-12000—12000
Max. resolution	1.25 mV	0.416 mV	1.0 mV	0.333 mV	2.5 mV	0.625 mV	0.75 mV	0.333 mV	
Current output <sup>②</sup>									
I/O characteristics	Current output	0—20 mA	0—20 mA	4—20 mA	4—20 mA	user defined	user defined	user defined	user defined
	Digital input	0—4000	0—12000	0—4000	0—12000	-4000—4000	-12000—12000	-4000—4000	-12000—12000
Max. resolution	5 μA	4 μA	1.66 μA	1.33 μA	1.5 μA	0.83 μA			
Overall accuracy	±0.3 % conforms to voltage ±30 mV, current ±60 μA (at 0—55 °C); ±0.1 % conforms to voltage ±10 mV, current ±20 μA (at 20—30 °C)								
Max. conversion time	80 μs/channel	10 ms/2 channels	80 μs/channel	6 ms /Kanal	80 μs/channel	80 μs/channel			
Insulation method	Photocoupler insulation between output terminals and PLC power	Each output is photocoupler insulated between each other and against the PLC power	Photocoupler insulation between output terminals and PLC power	Transformer insulation between the output channels and between the channels and PLC power.	Photocoupler insulation between output terminals and PLC power	Photocoupler insulation between output terminals and PLC power			
I/O points	16	16	16	16	16	16			
Connection terminal	Removable terminal block with 18 screw terminals	Removable terminal block with 18 screw terminals	Removable terminal block with 18 screw terminals	40-pin connector at the front	Removable terminal block with 18 screw terminals	Removable terminal block with 18 screw terminals			
Applicable wire size	mm <sup>2</sup> 0.3—0.75	0.3—0.75	0.3—0.75	0.3	0.3—0.75	0.3—0.75			
Internal power consumption (5 V DC)	mA 330	370	340	620	390	380			
Weight	kg 0.19	0.20	0.19	0.22	0.18	0.18			
Dimensions (WxHxD)	mm 27.4x98x90	27.4x98x90	27.4x98x90	27.4x102x130	27.4x98x90	27.4x98x90			
Order information	Art. no. 200689	145037	200690	204677	200691	200692			

① Values are valid for all modules except for Q68DAIN; ② Values are valid for all modules except for Q68DAVN



## Analog Modules for Temperature Measurement

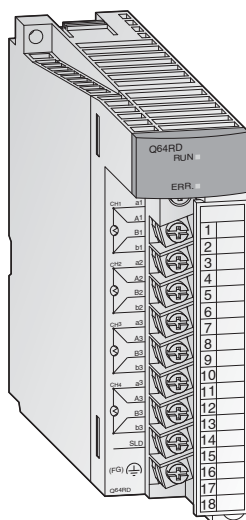

### Temperature measurement by temperature sensors

These modules are designed to convert external platinum temperature-measuring resistor input values into 16 or 32-bit signed binary temperature measurement values and scaling values.

The reference temperature is determined by means of a Pt100 resistance thermometer for the Q64RD module (Q64RD-G additionally with Ni100 resistors) and by means of a thermocouple for the Q64TD and Q64TDV-GH modules.

### Special features:

- Temperature of 4 channels can be measured by one module
- Two kinds of platinum temperature measuring resistors compliant with the JIS, IEC and DIN standards are supported.
- The disconnection of a platinum temperature-measuring resistor or cable can be detected on each channel
- Selection of sampling processing/time averaging processing/count averaging processing
- Error compensation by offset/gain value setting
- Alarm output when limit value is exceeded
- Potential isolation between process and control by means of an optocoupler is a standard feature. Additional potential isolation between the channels for Q64TDV-GH and Q64RD-G.
- Removable terminal block fastened with screws.

Specifications	Q64RD	Q64RD-G	Q64TD	Q64TDV-GH	Q68RD3-G	Q68TD-G-H01/H02
Input channels	4	4	4	4	8	8
Connectable temperature sensors	type Pt100 (conforms to JIS C 1604-1989 and DIN IEC 751), JPt100 (conforms to JIS C 1604-1981)	Pt100 (conforms to JIS C 1604-1997 and DIN IEC 751-1983), JPt100 (conforms to JIS C 1604-1981), Ni100Ω (conf. to DIN 43760-1987)	K, E, J, T, B, R, S, N (conforms to JIS C1602-1995, IEC 584-1 and 584-2)	K, E, J, T, B, R, S, N (conforms to JIS C1602-1995, IEC 584-1 and 584-2)	Pt100 (conf. JIS C 1604-1997 and DIN IEC 751), JPt100 (conf. to JIS C 1604-1981), Ni100Ω (conf. to DIN 43760-1987)	K, E, J, T, B, R, S, N (conf. to JIS C1602-1995, IEC 584-1 and 584-2)
Temperature measuring range	Pt100: -200–850 °C, JPt 100: -180–600 °C	Pt100: -200–850 °C, JPt 100: -180–600 °C, Ni100Ω: -60–180 °C	Depends on the thermocouple used	Depends on the thermocouple used	Pt100: -200–850 °C, JPt 100: -180–600 °C, Ni100Ω: -60–180 °C	Depends on the thermocouple used
Temperature scaling value	16-bit, signed binary: -2000–+8500 32-bit, signed binary: -200 000–+850 000	16-bit, signed binary: -2000–+8500 32-bit, signed binary: -200 000–+850 000	16-bit, signed binary: -2700–+18 200 32-bit, signed binary: —	16-bit, signed binary: -25 000–+25 000 32-bit, signed binary: —	16-bit, signed binary: -2000–+8500	16-bit, signed binary: -2700–+18200
Max. resolution	0.025	0.025 °C	B, R, S, N: 0.3 °C; K, E, J, T: 0.1 °C	B: 0.7 °C; R, S: 0.8 °C; K, T: 0.3 °C; ET: 0.2 °C; J: 0.1 °C; N: 0.4 °C; Voltage: 4 μV	0.1 °C	B, R, S, N: 0.3 °C; K, E, J, T: 0.1 °C
Cold junction temp. compensation accuracy	—	—	±1.0 °C	±1.0 °C	—	provided
Overall accuracy	±0.08 % (accuracy relative to full-scale value) at ambient temperature 25 ± 5 °C	±0.04 % (accuracy relative to full-scale value) at ambient temperature 25 ± 5 °C	Depends on the thermocouple used	Depends on the thermocouple used	Depends on the sensor used	Depends on the thermocouple used
Max. conversion time	40 ms/channel	40 ms per channel	20 ms/channel	20 ms/channel	320 ms/8 channels	320 ms/8 channels (H01), 640 ms/8 channels (H02)
Analog inputs	4 channels/module	4 channels/module	4 channels/module + Pt100 connection	4 channels/module + Pt100 connection	8 channels	8 channels/module
Temp. measurement output current	1 mA	1	—	—	1	—
Insulation method	Transformer insulation ①	Photocoupler insulation ② Transformer insulation ③	Transformer insulation ④	Transformer insulation ⑤	Transformer insulation ⑤	Transformer insulation ⑤
Disconnection detection	For each channel independent	For each channel independent	For each channel independent	For each channel independent	For each channel independent	For each channel independent (just Q68TD-G-H02)
I/O points	16	16	16	16	16	16
Connection terminal	All modules are fitted with a removable terminal block with 18 screw terminals.				A6CON 40pin connector	A6CON 40pin connector
Applicable wire size	mm <sup>2</sup> 0.3–0.75	0.3–0.75	0.3–0.75	0.3–0.75	≤ 0.3	≤ 0.3
Internal power consumption (5 V DC)	600 mA	620	500	500	0.54 A	0.49 A (H01) 0.65 A (H02)
Weight	kg 0.17	0.20	0.25	0.25	0.20	0.17
Dimensions (WxHxD)	mm 27.4x98x90	27.4x98x112	27.4x98x90	27.4x98x90	27.4x102x130	27.4x98x90 (H01) 27.4x102x130 (H02)
Order information	Art. no. 137592	154749	137591	143544	216482	216481/221582

① between power supply and temperature inputs ② between each channel and PLC power ③ between measuring input channels ④ between thermocouple inputs as well as thermocouple and earth

⑤ between each channel and between the channels and PLC power

Temperature Control Modules

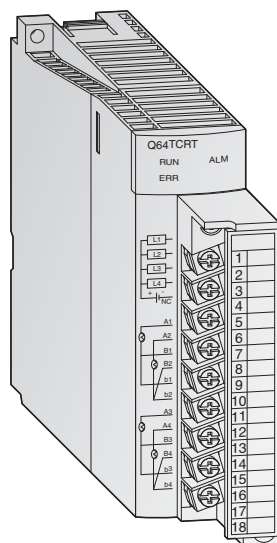

Temperature control modules with PID algorithm

These modules enable PID algorithm temperature control without placing any load on the PLC CPU for the temperature control tasks.

Special features:

- Four temperature input channels
- Auto-tuning function for the 4 PID control circuits
- Temperature control can continue even when the PLC program is stopped
- Transistor output with pulse train to drive the actuator in the control circuit
- The module is provided with a removable terminal block fastened with screws.

Specifications	Q64TCRT	Q64TCRTBW	Q64TCTT	Q64TCTTBW
Control output type	Transistor	Transistor	Transistor	Transistor
Inputs	4 channels per module	4 channels per module/ broken wire detection	4 channels per module	4 channels per module/ broken wire detection
Supported temperature sensors	Pt100 (-200~+600 °C), JPt100 (-200~+500 °C)		R, K, J, T, S, B, E, N, U, L, P L II, W5Re/W26Re	
Sampling cycle	0.5 s/4 channels	0.5 s/4 channels	0.5 s/4 channels	0.5 s/4 channels
Control output cycle	1-100 s	1-100 s	1-100 s	1-100 s
Input filter	1-100 s (0 s: input filter OFF)	1-100 s (0 s: input filter OFF)	1-100 s (0 s: input filter OFF)	1-100 s (0 s: input filter OFF)
Temperature control method	PID ON/OFF impulse or 2-position control		PID ON/OFF impulse or 2-position control	
PID constant range	PID constant setting	Setting with automatic tuning possible		Setting with automatic tuning possible
	Proportional band P	0.0-1000 % (0 %: 2-position control)		0.0-1000 % (0 %: 2-position control)
	Integral time I	1-3600 s	1-3600 s	1-3600 s
	Differential time D	1-3600 s (0 setting for PID control)	1-3600 s (0 setting for PID control)	1-3600 s (0 setting for PID control)
Target value setting range	Within the temperature range of the Pt100 sensor used		Within the temperature range of the thermocouple used	
Dead band setting range	0.1-10.0 %	0.1-10.0 %	0.1-10.0 %	0.1-10.0 %
Transistor output	Output signal (sink)	ON/OFF pulse	ON/OFF pulse	ON/OFF pulse
	Rated load voltage	10-30 V DC	10-30 V DC	10.2-30 V DC
	Max. load current	0.1 A/1 point, 0.4 A/common	0.1 A/1 point, 0.4 A/common	0.1 A/1 point, 0.4 A/common
	Max. rush current	400 mA for 10 ms	400 mA for 10 ms	400 mA for 10 ms
	Max. voltage drop when ON	0.1 V DC (TYP) 0.1 A 2.5 V DC (MAX) 0.1 A	0.1 V DC (TYP) 0.1 A 2.5 V DC (MAX) 0.1 A	0.1 V DC (TYP) 0.1 A 2.5 V DC (MAX) 0.1 A
	Response time	OFF → ON: < 2 ms ON → OFF: < 2 ms	OFF → ON: < 2 ms ON → OFF: < 2 ms	OFF → ON: < 2 ms ON → OFF: < 2 ms
Insulation method	Transformer	Transformer	Transformer	Transformer
I/O points	16/1 slot	32/2 slots	16/1 slot	32/2 slots
Connection terminals	All modules are fitted with a terminal block with 18 screw terminals.			
Applicable wire size	0.3-0.75 mm <sup>2</sup>	0.3-0.75	0.3-0.75	0.3-0.75
Internal power consumption (5 V DC)	550 mA	60	550	640
Weight	0.2 kg	0.3	0.2	0.3
Dimensions (WxHxD)	27.4x98x90 mm	27.4x98x90	27.4x98x90	27.4x98x90
Order information	Art. no. 136386	136387	136388	136389

## Load Cell Input Module

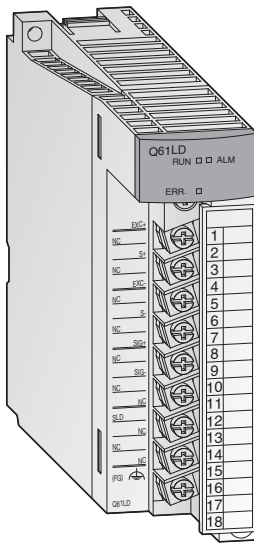

The load cell input module Q61LD can connect load cells directly to MELSEC Q series programmable controllers. External signal converters are no longer required.

### Special features:

- An external signal converter is not required. Man-hours and costs are reduced by using a load cell input module that can be connected directly to a programmable controller.
- The module achieves a highly accurate measurement with steady data conversion speed that guarantees the accuracy of load cells.
- Enhanced convenience with functions like zero offset, two-point calibration and input signal error detection.

Specifications	Q61LD
Analog input (load cell output) points	1
Analog input (load cell output)	mV/V 0.0–3.3
Analog input range (load cell rated output)	mV/V 0.0–1.0 0.0–2.0 0.0–3.0
Load cell applied voltage	5 V DC $\pm 5\%$ , Output current within 60 mA (Four 350 $\Omega$ load cells can be connected in parallel.) 6-wire system (Combination use of remote sensing method and ratiometric method) or 4-wire system
Digital output	32-bit signed binary, 0–10 000
Gross weight output (Max. weighing output value)	32-bit signed binary, -99999–99999 (Excluding decimal point and unit symbol)
Zero adjustment range	mV/V 0.0–3.0
Gain adjustment range	mV/V 0.3–3.2
Resolution	0–10 000
Accuracy	Nonlinearity: within $\pm 0.01\%$ /FS (Ambient temperature: 25 °C)
Conversion speed	ms 10
Insulation method	Photocoupler insulation
Number of occupied I/O points	16
External connection system	18-point terminal block
Applicable wire size	mm <sup>2</sup> 0.3–0.75
Internal power consumption (5 V DC)	A 0.48
Weight	kg 0.17
Dimensions (WxHxD)	mm 27.4x98x90
<b>Order information</b>	Art. no. 229237

Loop Control Module

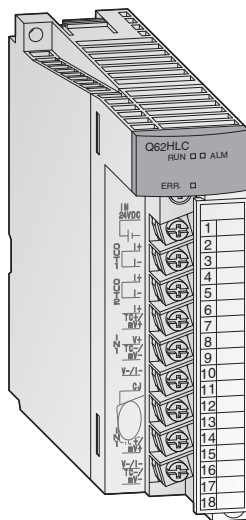

For fast response control

The Q62HLC loop control module uses a continuous proportional PID control format, which features a sampling period of 25 ms for high-accuracy, high-resolution thermocouple inputs, microvoltage inputs, voltage inputs, current inputs and current outputs. These features make the Q62HLC ideal for applications such as rapid temperature increase control, pressure control and flow rate control.

Special features:

- Staggering 25 ms sampling and control update time make the Q62HLC to one of the fastest control module in the market
- Supports sensor types, such as thermocouple, microvoltage, voltage and current input range
- Continuous proportional PID control by 4 to 20 mA current output results in highly stable and accurate control
- Control program profiles can be specified where set values and PID constants are automatically changed at specific times.
- Cascade control can be performed with channel 1 as the master and channel 2 as the slave.

Specifications		Q62HLC	
Number of input channels		2	
Analog input	Thermocouple	°C	-200—+2300 (0.1 °C resolution)
	Micro voltage	mV	-100—+100 (0.5—10 μV resolution)
	Voltage	V	-10—+10 (0.05—1 mV resolution)
	Current	mA	0—20 (0.8—1 μA resolution)
Digital output		-2000—+23000, -10000—+10000, -10000—+10000, 0—20000	
Supported thermocouples		K, J, T, S, R, N, E, B, PL II, W5re/W26Re	
Max. conversion speed		25 ms/2 channels	
Normal mode rejection ratio		60 dB or more (50/60 Hz)	
Common mode rejection ratio		120 dB or more (50/60 Hz)	
Input filter (primary delay digital filter)		0.0—100.0 s	
Sensor compensation value setting		-50.00—50.00 %	
Control method		Continuous proportional control	
PID constant range	PID constant setting	Setting possible by auto-tuning	
	Proportional band (P)	Thermocouple: 0.1 to full scale °C; micro voltage, voltage, current: 0.1—1000.0 %	
	Integral time (I)	s	0.0—3276.7
	Differential time (D)	s	0.0—3276.7
Set value setting range		Thermocouple: input range of thermocouple being used	
Dead band setting range		0.1—10.0 %	
I/O points		16	
Isolation		Transformer isolation between the input channels and between the inputs and ground	
Connection terminals		Terminal block with 18 screw terminals.	
Applicable wire size		mm <sup>2</sup>	0.3—0.75
External power supply		24 V DC, 70 mA	
Internal power consumption (5 V DC)		mA	270
Weight		kg	0.25
Dimensions (WxHxD)		mm	27.4x98x112
Order information		Art. no.	200693

## High-Speed Counter Modules

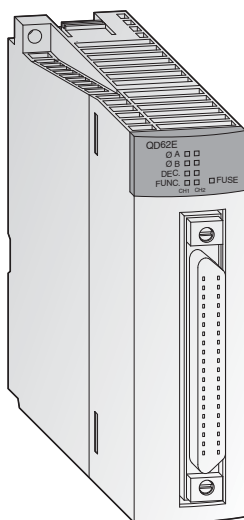

### High-speed counter with automatic detection of rotation direction

These counter modules detect signals with a frequency which cannot be detected by normal input modules. For example, simple positioning tasks or frequency measurements can be realized.

#### Special features:

- Input for incremental shaft encoder with automatic forward and reverse detection
- Preset count via external signals or the PLC program with the aid of the PRESET function
- Ring counter function for counting up to a predefined value with automatic resetting to the starting value
- Functions such as speed measurement, definition of switching points or periodic counting are available.
- The modules QD62□ are provided with a 40-pin connector interface (for suitable connectors, please refer to the chapter "Accessories").
- The module QD60P8-G is provided with a removable terminal block fastened with screws.

Specifications	QD62E	QD62	QD62D	QD60P8-G	QD63P6
Counter inputs	2	2	2	8	6
Signal levels	5/12/24 V DC (2–5 mA)	5/12/24 V DC (2–5 mA)	5/12/24 V DC (2–5 mA) (RS422A)	5/12/24 V DC	5 V DC (6.4–11.5 mA)
Max. counting frequency	kHz 200	200	500 (differential)	30	200
Max. counting speed	1-phase-input	200 or 100	500 or 200	30	200,100 or 10
	2-phase-input	200 or 100	500 or 200	—	200,100 or 10
Counting range	32 bits + sign (binary), -2147483648—+2147483647	32 bits + sign (binary), -2147483648—+2147483647	32 bits + sign (binary), -2147483648—+2147483647	16 bits binary: 0–32767 32 bits binary: 0–99999999 32 bits binary: 0–2147483647	32 bits + sign (binary), -2147483648—+2147483647
Counter type	All modules are equipped with UP/DOWN preset counter and ring counter function.			Moving average function, alarm output and pre-scale function	UP/DOWN preset counter and ring counter function
Comparison range	32 bits + sign (binary)	32 bits + sign (binary)	32 bits + sign (binary)	32 bits + sign (binary)	32 bits + sign (binary)
External digital input points	Preset, function start				—
Rated voltage/current for external input	5/12/24 V DC (2–5 mA)	5/12/24 V DC (2–5 mA)	5/12/24 V DC (2–5 mA) (RS422A)	5/12/24 V DC	4.5–5.5 V/6.4–11.5 mA
External digital output points (coincidence signal)	2 points/channel 12/24 V DC 0.1 A/point, 0.4 A/common (source)	2 points/channel 12/24 V DC 0.5 A/point, 2.0 A/common (sink)	2 points/channel 12/24 V DC 0.5 A/point, 2.0 A/common (sink)	—	—
I/O points	16	16	16	32	32
Connection terminal	40-pin connector interface on the front	40-pin connector interface on the front	40-pin connector interface on the front	Terminal block with 18 screw terminals	40-pin connector
Applicable wire size	mm <sup>2</sup> 0.3	0.3	0.3	0.3–0.75	0.3
Internal power consumption (5 V DC)	mA 330	300	380	580	590
Weight	kg 0.12	0.11	0.12	0.17	0.15
Dimensions (WxHxD)	mm 27.4x98x90	27.4x98x90	27.4x98x90	27.4x98x90	27.4x98x90
<b>Order information</b>	Art. no. 128949	132579	132580	145038	213229
Accessories	40-pin connector and ready to use connection cables (refer to page 50–52)				



**Positioning Modules**

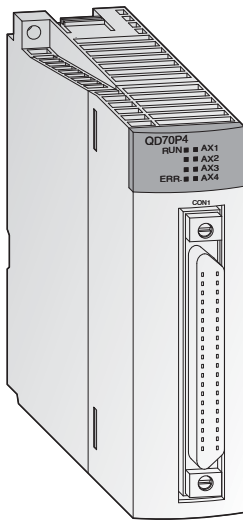

**Multi-axis positioning**

The modules are especially designed for systems including multiple axes that do not require any extensive control. The QD70P4 controls up to 4 axes and the QD70P8 up to 8 axes. Since any number of positioning modules can be used the number of axes to be controlled as well is unlimited.

**Special features:**

- Control of 4 or 8 axes by one module and more than 8 axes by using multiple modules
- Quick start of up to 8 axes simultaneously (0.1 ms per axis after start command from the CPU)
- Various positioning control systems are selectable.
- Easy parametrizing and positional data setup via optionally available positioning software GX Configurator-PT

Specifications	QD70P4	QD70P8
Number of control axes	4	8
Interpolation	—	
Points per axis	10 (by PLC program or with the positioning software GX Configurator PT)	
Output signal	Pulse chain	
Output frequency	kHz 1–200 000	
Positioning method	PTP positioning; speed/locus positioning; path control	
Positioning	Units	Absolute data: -2 147 483 648–2 147 483 647 pulse Incremental method: -2 147 483 648–2 147 483 647 pulse Speed/position switching control: 0–2 147 483 647 pulse
	Speed	0–200 000 pulse/s
	Acceleration/deceleration processing	Automatic, acceleration and deceleration step by step
	Acceleration and deceleration time	0–32767 ms
Pulse output type	Open collector output	
Max. servo motor cable length	m 2	2
I/O points	32	32
Applicable wire size	0.3 mm <sup>2</sup> (with connector A6CON1); AWG24 (with connector A6CON2)	
Internal power consumption (5 V DC)	mA 550	740
External power consumption (24 V DC)	mA 65	120
Weight	kg 0.15	0.17
Dimensions (WxHxD)	mm 27.4x98x90	27.4x98x90
<b>Order information</b>	Art. no. 138328	138329
Accessories	40-pin connector and ready to use connection cables (refer to page 50–52)	

## Positioning Modules

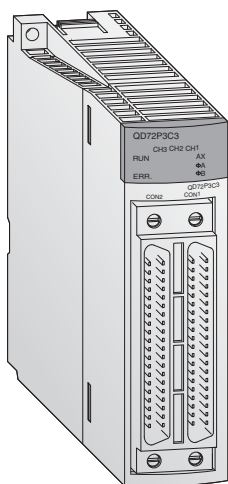

### Space efficient positioning

The QD72P3C3 realizes positioning applications with less space requirements.

### Special features:

- Minimized space requirement!
- 3-axis positioning and 3-channel counter functions are available in a single module.
- Optimum solution for specific applications!
- Positioning can be controlled by confirming actual movement amount from encoder inputs.

Specifications		QD72P3C3
Number of control axes		3
Interpolation		—
Positioning	Data times	1 per axis
	Method	PTP control: absolute data and/or incremental
	Control range	-1073741824–1073741823 pulses
	Speed	0–100 000 pulse/s
	Acceleration/deceleration processing	Trapezoidal
	Acceleration and deceleration time	ms 1–5000
	Start time	Positioning control, speed control: 1 ms
	Pulse output method	Open collector output
Counter function	Max. output pulse	kpps 100
	Number of channels	3
	Count input signal	1-phase input, 2-phase input; 5–24 V DC
	Counting speed	kpps 100
Counting range	31-bit signed binary (-1073741824–1073741823)	
External connection		40-pin connector
Internal power consumption (5 V DC)		A 0.57
I/O points		32
Weight		kg 0.15
Dimensions (WxHxD)		mm 27.4x98x90
<b>Order information</b>		Art. no. 213230
Accessories		40-pin connector and ready to use connection cables (refer to page 50–52)

■ Positioning Modules

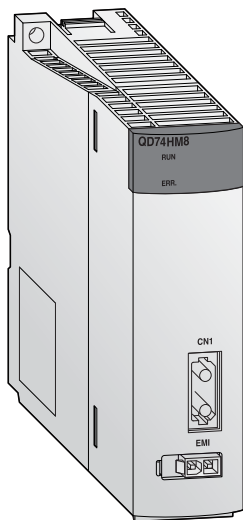

**SSCNET positioning**

The positioning modules QD74MH are used to control multiple axes via the high speed motion network SSCNETIII.

**Special features:**

- Eight and sixteen axes positioning modules are available.
- The operation cycle is 0.88 ms
- Easy positioning control functions
- A positioning operation starts up quickly taking as little as 0.88 ms.
- SSCNET III makes the connection to the servo amplifier possible
- Easy application to the absolute position system

Specifications	QD74MH8	QD74MH16	
Number of control axes	8	16	
Interpolation	2 to 4 axes linear interpolation (up to 4 groups)		
Control methods	PTP control/locus control (linear only)		
Control units	Pulse		
Positioning data	32 data (positioning data no.1 to 32)/axis (by sequence program)		
Back-up	Basic parameters, OPR parameters, Manual control parameters, System parameters, Servo parameters and positioning parameters can be saved in the flash ROM. (Battery less)		
Positioning	Method	PTP control: incremental and/or absolute data; locus control: incremental and/or absolute data	
	Range	Absolute data: -2 147 483 648–2 147 483 647 pulse Incremental method: -2 147 483 648–2 147 483 647 pulse	
	Speed command range	5–2147000000 pulse/s	
	Acceleration/deceleration processing	Linear, S-curve	
	Acceleration and deceleration time	ms 0–20000	
	Rapid stop deceleration time	ms 0–20000	
Number of SSCNET III systems	1		
Number of write accesses to flash ROM	Up to 100 000		
I/O points	32		
Internal power consumption (5 V DC)	A	0.7	
Weight	kg	0.15	
Dimensions (WxHxD)	mm	27.4x98x90	
<b>Order information</b>	Art. no.	218106	217994
Accessories	SSCNET III cable (MR-J3BUS□M(-A/-B))		

## Positioning Modules

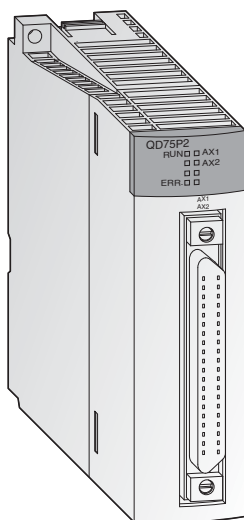

### Positioning with an open control loop

The modules generate the travel command via a pulse chain. The speed is proportional to the pulse frequency and the distance travelled is proportional to the pulse length.

### Special features:

- Control of up to three axes with linear interpolation (QD75P4) or circular interpolation (QD75P2, QD75P4)
- Storage of up to 600 positional data in the flash ROM (no back-up battery necessary)
- Units of travel can be defined in pulses, mm, inches or degrees.
- Configuration and presetting of all 600 positional data is performed via the PLC program or with the aid of the programming software GX Configurator QP. This software runs under Windows 95/98 and Windows 2000/NT.

Specifications	QD75P1	QD75P2	QD75P4
Number of control axes	1	2	4
Interpolation	—	2 axis linear and circular interpolation	2, 3, or 4 axis linear and 2 axis circular interpolation
Points per axis	600 pieces of data with PLC program, 100 pieces of data with GX Configurator QP		
Output type	Open collector	Open collector	Open collector
Output signal	Pulse chain	Pulse chain	Pulse chain
Output frequency	kHz 1–200	1–200	1–200
Positioning	Method	PTP control: absolute data and/or incremental; speed/position switching control: incremental; locus/speed control: incremental; path control: absolute data and/or incremental	
	Units	Absolute data:	
		Incremental method:	
	Speed/position switching control:	0 – 2 147 483 647 pulse 0 – 21 478 364,7 µm 0 – 21 474,83647 inch 0 – 21 474,83647 degree	
Speed	1 – 1 000 000 pulse/s 0.01 – 20 000 000.00 mm/min 0.001 – 200 000.000 degree/min 0.001 – 200 000.000 inch/min		
Acceleration/deceleration processing	Automatic trapezoidal or S-pattern acceleration and deceleration or automatic S-pattern acceleration and deceleration		
Acceleration and deceleration time	1–8388608 ms (4 patterns each can be set)		
Rapid stop deceleration time	1–8388608 ms		
Max. length for servo motor cable	m 2	2	2
I/O points	32	32	32
Internal power consumption (5 V DC)	mA 400	460	580
Weight	kg 0.15	0.15	0.16
Dimensions (WxHxD)	mm 27.4x98x90	27.4x98x90	27.4x98x90
Order information	Art. no. 132581	132582	132583
Accessories	40-pin connector and ready to use connection cables (refer to page 50–52); Programming software: GX Configurator QP, art. no.: 132219		

■ Positioning Modules

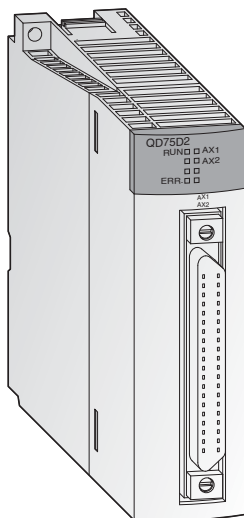

**Long distance positioning**

The modules of the QD75 series are suitable for bridging long distances between module and drive system.

The modules QD75D provide differential outputs, whereas the QD75M and QD75MH are designed for the operation across the motion network SSCNET.

**Special features:**

- Control of up to four axes with linear interpolation (QD75D4/QD75M4/QD75MH4) or two axes circular interpolation (all modules except QD75D1/QD75M1/QD75MH1)
- Storage of up to 600 positional data in the flash ROM (no back-up battery necessary)
- Units of travel can be defined in pulses, mm, inches or degrees.
- Configuration and presetting of all 600 positional data is performed via the PLC program or with the aid of the programming software GX Configurator QP.

Specifications	QD75D1	QD75M1	QD75MH1	QD75D2	QD75M2	QD75MH2	QD75D4	QD75M4	QD75MH4	
Number of control axes	1	1	1	2	2	2	4	4	4	
Interpolation	—	—	—	2 axis linear and circular interpolation			2, 3, or 4 axis linear and 2 axis circular interpolation			
Points per axis	600 pieces of data with PLC program, 100 pieces of data with GX Configurator QP									
Output type	Differential driver	SSCNET	SSCNET III	Differential driver	SSCNET	SSCNET III	Differential driver	SSCNET	SSCNET III	
Output signal	Pulse chain	BUS	BUS	Pulse chain	BUS	BUS	Pulse chain	BUS	BUS	
Output frequency	kHz 1–1000									
Positioning	Method	PTP control: absolute data and/or incremental; speed/position switching control: incremental; locus/speed control: incremental; path control: absolute data and/or incremental								
	Units	Absolute data: -2 147 483 648 – 2 147 483 647 pulse -21 478 364.8 – 214 748 364.7 μm -21 474.83648 – 21 474.83647 inch 0 – 359.99999 degree Incremental method: -2 147 483 648 – 2 147 483 647 pulse -214 748 364.8 – 214 748 364.7 μm -21 474.83648 – 21 474.83647 inch -21 474.83648 – 21 474.83647 degree Speed/position switching control: 0 – 2 147 483 647 pulse 0 – 21 478 364.7 μm 0 – 21 474.83647 inch 0 – 21 474.83647 degree								
	Speed	1 – 1 000 000 pulse/s 0.01 – 20 000 000.00 mm/min 0.001 – 200 000.000 degree/min 0.001 – 200 000.000 inch/min								
	Acceleration/deceleration processing	Automatic trapezoidal or S-pattern acceleration and deceleration or automatic S-pattern acceleration and deceleration								
Acceleration and deceleration time	1–8388608 ms (4 patterns, each can be set)									
Rapid stop deceleration time	1–8388608 ms									
Max. length for servo motor cable	m 10	30	30	10	30	30	10	30	30	
I/O points	32									
Internal power consumption (5 V DC)	mA 520	520	520	560	560	560	820	820	820	
Weight	kg 0.15	0.15	0.15	0.15	0.15	0.15	0.16	0.16	0.16	
Dimensions (WxHxD)	mm 27.4x98x90	27.4x98x90	27.4x98x90	27.4x98x90	27.4x98x90	27.4x98x90	27.4x98x90	27.4x98x90	27.4x98x90	
<b>Order information</b>	Art. no.	129675	142153	165761	129676	142154	165762	129677	142155	165763
Accessories	40-pin connector and ready to use connection cables (refer to page 50–52); Programming software: GX Configurator QP, art. no.: 132219									



## Interface Modules

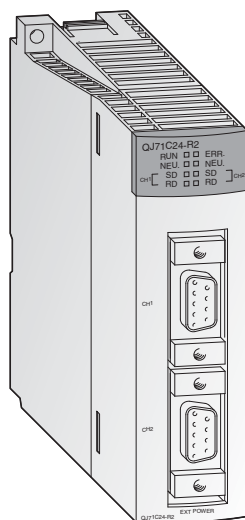

### Data exchange with peripheral devices

This module enables communication with peripheral devices via a standard RS232 interface. The peripherals are connected point-to-point on a 1:1 basis.

### Special features:

- The QJ71C24N provides one RS232 and one RS422/485 interface. The QJ71C24-R2 provides two RS232 interfaces and the QJ71C24N-R4 two RS422/485 interfaces.
- Enables PCs connected to the system to access the full data set of the MELSEC System Q CPU using graphic process supervision or monitoring software
- Integrated flash ROM memory for logging quality, productivity or alarm data that can be printed out when required
- Module and communications status shown by LEDs
- Communications test and monitor function are possible with the software GX-Configurator UT

Specifications		QJ71C24N	QJ71C24N-R2	QJ71C24N-R4	QJ71MB91	
Interface	channel 1	RS232 (9-pin Sub-D)	RS232 (9-pin Sub-D)	RS422/RS485 (screw terminals)	RS232 (9-pin Sub-D)	
	channel 2	RS422/RS485 (screw terminals)	RS232 (9-pin Sub-D)	RS422/RS485 (screw terminals)	RS422/RS485 (screw terminals)	
Communications mode		Full duplex/half duplex	Full duplex/half duplex	Full duplex/half duplex	Full duplex/half duplex	
Synchronisation		Asynchronous communications	Asynchronous communications	Asynchronous communications	Master/Slave	
Data transfer	Rate	50–230400 (channel 1 only) 115200 (channel 1+2 simultaneously)	50–230400 (nur Kanal 1) 115200 (channel 1+2 simultaneously)	50–230400 (channel 1 only) 115200 (channel 1+2 simultaneously)	300–115200	
	Distance RS232	m	15	—	15	
	Distance RS422/485	m	1200 (if both channels are used)	—	1200 (if both channels are used)	1200
Max. no of stations in a multidrop network		No restrictions/64	—	no restrictions/64	Master (32 slaves) Slave (242)	
Data format		1 start bit, 7 or 8 data bits, 1 or 0 parity bits, 1 or 2 stop bits	1 start bit, 7 or 8 data bits, 1 or 0 parity bits, 1 or 2 stop bits	1 start bit, 7 or 8 data bits, 1 or 0 parity bits, 1 or 2 stop bits	Modbus RTU	
Error correction		Parity check, checksum	Parity check, checksum	Parity check, checksum	—	
DTR/DSR control		YES/NO selectable	YES/NO selectable	—	—	
X ON/X OFF (DC1/DC3)		YES/NO selectable	YES/NO selectable	YES/NO selectable	—	
I/O points		32	32	32	32	
Internal power consumption (5 V DC)		mA	310	260	390	310
Weight		kg	0.2	0.2	0.2	0.2
Dimensions (WxHxD)		mm	27.4x98x90	27.4x98x90	27.4x98x90	27.4x98x90
Order information		Art. no.	149500	149501	149502	167757

High-Speed Communication Modules

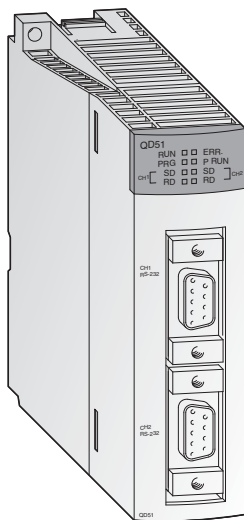

Programmable interface module

This module works through its own program independently of the PLC CPU. Thus, peripherals can be operated or mathematical operations performed without imposing an additional load on the PLC CPU. Programming is in AD51H-BASIC.

Special features:

- Two RS232C interfaces and one RS422/485 interface
- Two BASIC programs can be operated in parallel (multitasking).
- The tasks can be stored in the module as interpreter programs or in compiled form.
- The integrated Flash ROM is used for storage.
- Online and offline program creation is possible.
- The module and communication status is indicated by means of LEDs.
- Support for plain ASCII data exchange with connected devices such as barcode readers, scales and identification systems

Specifications		QD51-R24	QD51
Interfaces	type	1 x RS422/485, 1 x RS232	2 x RS232
Microprocessor	type	V53A (20 MHz)	V53A (20 MHz)
Number of parallel tasks		Max. 2	Max. 2
Start conditions for tasks		Started by power on, started by the start command from another task, start by an interruption from the PC CPU.	
Data transfer	Rate	bit/s	≤ 38 400
	Distance	m	500 (RS422/485), 15 (RS232C)
Program language		AD51H-BASIC	AD51H-BASIC
Internal memory	Program memory	kbyte	64 x 1 task or 32 x 2 tasks
	Common memory for tasks	kbyte	8
	Data buffer to PLC	kbyte	6
	Extension relays		1024
	Extension data registers		1024 (2 kbyte)
Memory backup capability		Provided for common memory, extension relay and extension register.	
Memory for programs		Flash memory: 64 kbyte	Flash memory: 64 kbyte
I/O points		32 (1 slot)	32 (1 slot)
Internal power consumption (5 V DC)	mA	310	260
Weight	kg	0.2	0.2
Dimensions (WxHxD)	mm	27.4x98x90	27.4x98x90
<b>Order information</b>	Art. no.	136385	136384
Accessories		For both modules: programming software for PC/AT (MS-DOS): SW11X-AD51HPE, art. no.: 33102	

## Network Modules

From simple stand alone systems and basic AS-Interface networks to Ethernet based networks and even Global networks based on Remote Telemetry Technology, Mitsubishi provides a wide range of network solutions.

Below you can find an overview on the currently available network modules. For more detailed informations please contact your nearest Mitsubishi distributor or the branch in your country.

### Ethernet Modules

Module	Specifications	Art. no.
QJ71E71-100	10BASE-T/100BASE-TX	138327
QJ71E71-B2	10BASE2	129614
QJ71E71-B5	10BASE5	147287

### MELSECNET/H Modules

#### MASTER

Module	Specifications	Art. no.
QJ71LP21-25	Fiber optic cable, dual loop, 25 Mbps/10 Mbps	136391
QJ71LP21S-25	Fiber optic cable, dual loop, 25 Mbps/10 Mbps, With external power supply function	147632
QJ71LP21G	GI-50/125 fiber optic cable, dual loop, 10 Mbps	138958
QJ71LP21GE	GI-62.5/125 fiber optic cable, dual loop, 10 Mbps	138959
QJ71BR11	Coaxial cable, single bus, 10 Mbps	127592

#### REMOTE I/O

QJ72LP25-25	Fiber optic cable, dual loop, 25 Mbps/10 Mbps	136392
QJ72LP25G	GI-50/125 fiber optic cable, dual loop, 10 Mbps	138960
QJ72LP25GE	GI-62.5/125 fiber optic cable, dual loop, 10 Mbps	138961
QJ72BR15	Coaxial cable, single bus, 10 Mbps	136393

#### PC I/F BOARD (PCI BUS)

Q80BD-J71LP21-25	Fiber optic cable, dual loop, 25 Mbps/10 Mbps	136367
Q80BD-J71LP21G	GI-50/125 fiber optic cable, dual loop, 10 Mbps	138962
Q80BD-J71LP21GE	GI-62.5/125 fiber optic cable, dual loop, 10 Mbps	138963
Q80BD-J71BR11	Coaxial cable, single bus, 10 Mbps	136366

### CC-Link Modules

#### MASTER/LOCAL

Module	Specifications	Art. no.
QJ61BT11N	CC-Link Ver. 2 compatible	154748
Q50J61BT12	Master module for CC-Link Safety	203209

#### MASTER/LOCAL INTERFACE BOARD (PCI BUS)

Q80BD-J61BT11N	CC-Link Ver. 2 compatible	200758
----------------	---------------------------	--------

### CC-Link IE Modules

Module	Specifications	Art. no.
QJ71GP21-SX	1 Gbps, master/slave module for F0 GI	208815
QJ71GP21S-SX	1 Gbps, master/slave module for F0 GI with external voltage supply	208816

#### MASTER/LOCAL INTERFACE BOARD (PCI BUS)

Q80BD-J71GP21-SX	1 Gbps, PCI PC card, master/slave for F0 GI	208817
Q80BD-J71GP21S-SX	1 Gbps, PCI PC card, master/slave for F0 GI with external voltage supply	208818

### PROFIBUS/DP Modules

Module	Specifications	Art. no.
QJ71PB92V	Interface master module (DP V1/V2)	165374
QJ71PB93D	Intelligent slave	143545

### DeviceNet Module

Module	Specifications	Art. no.
QJ71DN91	Interface master/slave module	136390

### AS-Interface Module

Module	Specifications	Art. no.
QJ71AS92	AS-i Standard Version 2.11, dual network master	143531

### MODBUS Module

Module	Specifications	Art. no.
QJ71MB91	Serial MODBUS interface master/slave module	167757
QJ71MT91	MODBUS/TCP interface master/slave module for Ethernet	155603

### Web Server Module

Module	Specifications	Art. no.
QJ71WS96	10BASE-T/100BASE-TX	147115

■ Web Server Module



**Access to the System Q via the Internet**

The web server module QJ71WS96 enables remote monitoring and maintenance of a System Q PLC system via the Internet.

**Special features:**

- Very easy setting functions integrated
- User needs only a Web browser for setting and monitoring.
- RS232 interface for modem connection
- Various connections for data exchange are possible: ADSL, modem, LAN, etc.
- Sending and receiving data via mail or FTP
- Integration of a self-designed web site and Java applets is possible
- Standard connection via ETHERNET to exchange data between other PLCs or PCs
- Events and CPU data protocol, storage functions

Specifications		QJ71WS96	
Module type		Web server, FTP server/client	
Transmission method		ETHERNET: CSMA/CD	
Interface	type	10BASE-T/100BASE-TX (mode is recognized automatically)	
Communications speed	Mbps	10BASE-T: 10 Mbps/100BASE-TX: 100 Mbps	
Max. segment length	m	100 (between hub and node)	
RS-232 communications data	Interface	RS232, 9-pin D-SUB	
	Transfer type	Duplex	
	Synchronisations method	Start/stop synchronisation	
	Transfer speed	MBit/s	9.6/19.2/38.4/57.6/115.2
	Transmission distance	m	Max. 15
	Data format		1 start bit, 8 data bits, 1 stop bit
	Transfer control		Floating control is possible (RS/CS)
Memory capacity	MB	5 (Standard-ROM); expandable with Compact Flash™ Card up to 512	
I/O points		32	
Internal power consumption (5 V DC)	mA	650	
Weight	kg	0.17	
Dimensions (WxHxD)	mm	27.5x98x90	
<b>Order information</b>	Art. no.	147115	

## MES Interface Module

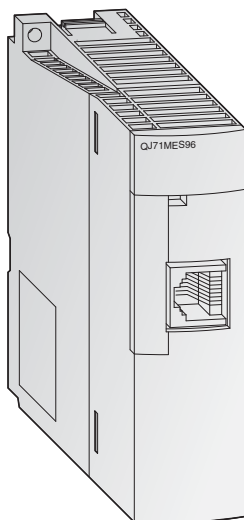

### Direct connection from the shop floor to the MES databases

The new Qseries MES module allows users to interface their production control systems directly to an MES database. (MES: Manufacturing Execution System).

#### Special features:

- It removes the need for an interfacing PC layer – reducing hardware costs and installation time.
- It removes the need for specialist interfacing software run on the PC layer; saving on expensive software and services while reducing installation costs.
- It simplifies the MES architecture reducing the total commissioning time.
- It can improve reliability and accessibility as the module is based on industrial PLC design standards.
- The simplified system provides greater direct data visibility increasing the opportunity to achieve higher productivity.

Specifications		QJ71MES96
Module type		MES interface module
Transmission method		ETHERNET
Interface	type	10BASE-T/100BASE-TX
Data base interface function	Common	Interacts with databases via user-defined jobs
	Tag function	Collects device data of the PLC CPUs on the network in units of tags
	Trigger monitoring function	Monitors the status of conditions (time, tag, values etc.) that initiate jobs
	Trigger buffering function	The MES interface module buffers the data and trigger time to internal memory
	SQL text transmission	Automatically generates the correct SQL message according to requirements of each supported database type.
	Arithmetic processing	Formulas can be applied to data before sending from the MES interface module.
	Program execution	Executes programs in the application server computer at the beginning and end of a job.
Software functions	No. of connected databases	32 items/project max.
	Supported databases	Oracle® 8i, Oracle® 9i, Oracle® 10g, Microsoft® SQL Server 2000, Microsoft® SQL Server 2000 Desktop Engine (MSDE2000), Microsoft® Access 2000, Microsoft® Access 2003
	No. of data settings	64 items/project max. (256 components/tag, 4096 components/project)
Memory capacity		1 Compact Flash™ card can be installed
I/O points		32
Internal power consumption (5 V DC)	mA	650
Weight	kg	0.16
Dimensions (WxHxD)	mm	27.5x98x90
<b>Order information</b>	Art. no.	200698



High Speed Data Logger Module

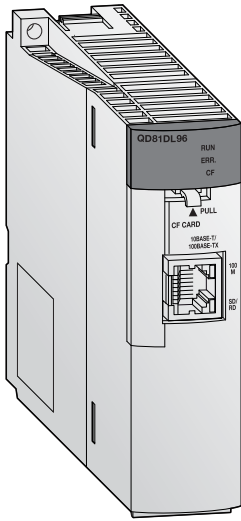

Easy data logging

The high speed data logger module can log programmable controller devices without using a personal computer. By easily configuring the module, sampled data can be saved in the optimal file format to a CompactFlash card.

Special features:

- Trigger logging function for accelerated problem analysis
- Data can be saved in list or report format to a CompactFlash Card
- Equipment error detection and failure prediction
- A single QD81DL96 module can access up to a maximum of 64 PLC CPUs

Specifications		QD81DL96
Ethernet	Interface <sup>①</sup>	10BASE-T/100BASE-TX
	Data transmission rate	10BASE-T: 10 Mbps/100BASE-TX: 100 Mbps
	Transmission method	Base band
	No. of cascaded stages	10BASE-T: max. 4/100BASE-TX: max. 2
	Max. segment length <sup>②</sup>	m 100
	Supported function	Auto-negotiation function supported (automatically distinguishes 10BASE-T/100BASE-TX)
CompactFlash card	Supply power voltage	3.3 V ±5 %
	Supply power capacity	mA Max. 150
	Card size	TYPE I card
	No. of installable cards	1
I/O points		32
Clock		Obtained from a programmable controller CPU (in multiple CPU system, CPU No. 1) or SNTP server Time accuracy after obtaining the time is a daily variation of ±9.504 seconds <sup>③</sup>
Internal power consumption (5 V DC)	A	0.46
Weight	kg	0.15
Dimensions (WxHxD)	mm	27.4x98x90
<b>Order information</b>	Art. no.	221934

<sup>①</sup> The high speed data logger module distinguishes 10BASE-T from 100BASE-TX according to the external device. For connection to a hub without an auto-negotiation function, set the hub to half-duplex communications mode.

<sup>②</sup> Distance between a hub and node.

<sup>③</sup> For programmable controller CPU, everyday (once in 24 hours); for SNTP server, re-obtains the time at the user specified interval.

## Interrupt Module and High-Speed Inputs

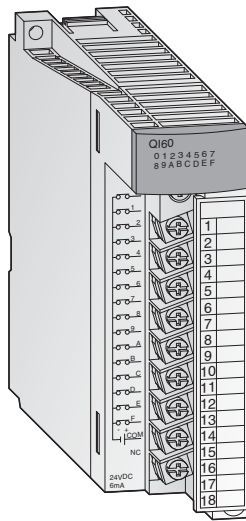

### Branching to subroutines

The interrupt module QI60 is suitable for applications demanding quick responses.

### Special features:

- Every input in this module is assigned to a pointer which serves as a branch mark for a subroutine.
- If an interrupt/alarm signal is applied at an input, the PLC program is interrupted after it has worked through the current statement and a subroutine assigned to the input is first processed.
- Galvanic isolation between process and controller by means of a photocoupler is a standard feature
- Only one QI60 can be installed per PLC system

### High-speed input modules

- Fast response times, 5  $\mu$ s–1 ms adjustable
- Input voltage 24 V and 5 V
- Can be configured as interrupt or input modul

Specifications		QI60	QX40H	QX70H	QX80H	QX90H	
Input points		16	16	16	16	16	
Rated input voltage	V DC	24 (sink type)	24	5	24	5	
Operating voltage range	V DC	20.4–28.8	20.4–28.8	4.25–6	20.4–28.8	4.25–6	
Max. input points simultaneous ON		100 %	100 %*	100 %	100 %*	100 %	
Input	resistance	k $\Omega$	Ca. 3.9	ca. 3.9	ca. 470 $\Omega$	ca. 3.9	ca. 470 $\Omega$
	current	mA	Ca. DC 4/8	ca. DC 6	ca. DC 6	ca. DC 6	ca. DC 6
ON	voltage	V	$\geq$ DC 19	$\geq$ DC 13	$\geq$ DC 3.5	$\geq$ DC 13	$\geq$ DC 3.5
	current	mA	$\geq$ DC 4	$\geq$ DC 3	$\geq$ DC 3	$\geq$ DC 3	$\geq$ DC 3
OFF	voltage	V	$\leq$ DC 11	$\leq$ DC 8	$\leq$ DC 1	$\leq$ DC 8	$\leq$ DC 1
	current	mA	$\leq$ DC 1.7	$\leq$ DC 1.6	$\leq$ DC 1	$\leq$ DC 1.6	$\leq$ DC 1
Response time	OFF $\rightarrow$ ON	ms	$\leq$ 0.2	0.04–0.95 (adjustable)	0.04–0.95 (adjustable)	0.04–0.95 (adjustable)	0.04–0.95 (adjustable)
	ON $\rightarrow$ OFF	ms	$\leq$ 0.3	0.04–0.95 (adjustable)	0.04–0.95 (adjustable)	0.04–0.95 (adjustable)	0.04–0.95 (adjustable)
Status display of inputs		LED	LED	LED	LED	LED	
Insulation method		All modules are fitted with photocoupler isolation between input terminals and internal circuit.					
No. of occupied I/O points		16	16	16	16	16	
Connection terminal		The module is fitted with a terminal block with 18 screw terminals.					
Applicable wire size	mm <sup>2</sup>	0.3–0.75	0.3–0.75	0.3–0.75	0.3–0.75	0.3–0.75	
Internal power consumption (5 V DC)	mA	60 (all points ON)	80 (all points ON)	80 (all points ON)	80 (all points ON)	80 (all points ON)	
Weight	kg	0.20	0.16	0.16	0.16	0.16	
Dimensions (W x H x D)	mm	27.4x98x90	27.4x98x90	27.4x98x90	27.4x98x90	27.4x98x90	
<b>Order information</b>	Art. no.	136395	221844	221855	221856	221857	

**Dummy Module**



**Place keeper and mechanical protection**

The dummy module QG60 protects unused slots on the base unit from dust and reserve I/O addresses.

**Special features:**

- Tough protection of unused slot
- Unified front view

Specifications	QG60	
I/O points	0–1024 (selectable)	
Application	Used to protect any vacant slot from dust.	
Current consumption	mA	—
Weight	kg	0.07
Dimensions (WxHxD)	mm	27.4x98x90
<b>Order information</b>	Art. no.	129853

**Connection Cables**

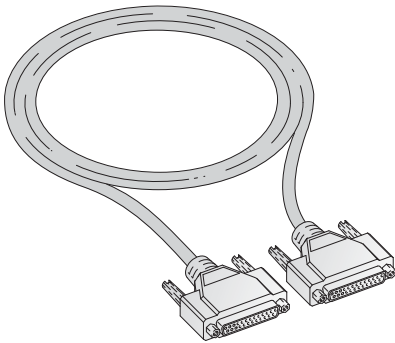

**Connection cable for extension units**

These connection cables are used for connecting base units to the extension units. They have been cut to the correct length for each application.

When the extension cables are used multiple, the overall distance of the cables should be within 13.2 m.

Specifications	QC05B	QC06B	QC12B	QC30B	QC50B	QC100B	
For extension base units	Q52B, Q55B	Q63B, Q65B, Q68B, Q612B	Q63B, Q65B, Q68B, Q612B	Q63B, Q65B, Q68B, Q612B	Q63B, Q65B, Q68B, Q612B	Q63B, Q65B, Q68B, Q612B	
Length	m	0.45	0.6	1.2	3.0	5.0	10.0
<b>Order information</b>	Art. no.	140380	129591	129642	129643	129644	129645

**Tracking Cable**

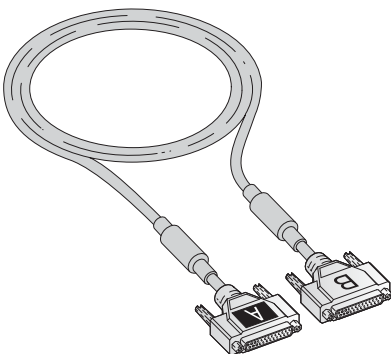

**Connection cable for redundant CPUs**

The tracking cable connects the two CPUs in a redundant system. Use only the QC10TR or QC30TR cables!

The connectors of the tracking cables are labelled A and B for System A and System B. When both systems are started at the

same time System A will be the active controller and System B will be the standby system.

The length of the extension cables cannot exceed 13.2 metre

Specifications	QC10TR	QC30TR	
Purpose	Connection of the two CPU modules in a redundant system (QnPRHCPU)		
Length	m	1.0	3.0
<b>Order information</b>	Art. no.	157068	157069

## ■ Programming Cable

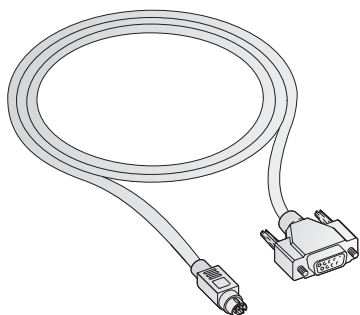

### Programming cable for USB and RS232 interface

The QC30R2 and QC30-USB cables are used for programming a MELSEC System Q CPU via the RS-232 and standard USB ports.

The programming cable provides a 9-pin D-sub connector for the PC side and a 6-pin Mini-DIN connector for the PLC interface.

The USB cable is especially suited for a fast connection between PC and CPU.

Specifications		QC30R2	QC30-USB	USB-CAB-5M
Connection cable for		Connection between a PCs and a MELSEC system Q PLC via RS232 interface	Connection of a PC to a MELSEC System Q CPU via a standard USB port	Connection of a PC to an iQ CPU in the MELSEC System Q via a mini-USB port
Length	m	3.0	3.0	5.0
<b>Order information</b>	Art. no.	128424	136577	221540
Accessories		Connector disconnection prevention holder Q6HLD-R2	—	—

## ■ Connector Disconnection Prevention Holder

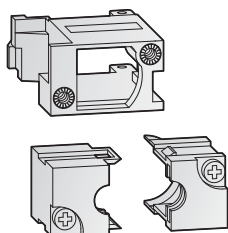

### Disconnection prevention for RS232 cable

The connector disconnection prevention holder Q6HLD-R2 securely locks the RS232 connector of the programming cable to the CPU and prevents the connector from

accidentally loosening (e.g. when connected to an HMI operator terminal).

Specifications		Q6HLD-R2
Application		Programming cable QC30R2
<b>Order information</b>	Art. no.	140381

## ■ Adapter Cables

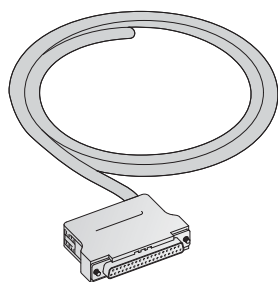

### Assembled cable with D-SUB plug

The cables Q32CBL-3m and Q32CBL-5M are used for connecting the modules QX81 and QY81P of the MELSEC Q.

Specifications		Q32CBL-3M	Q32CBL-5M	Q32CBL-10M
Connection cable for	type	QX81/QY81P	QX81/QY81P	QX81/QY81P
Length	m	3.0	5.0	10.0
<b>Order information</b>	Art. no.	136575	136576	158066

40-Pin Connectors

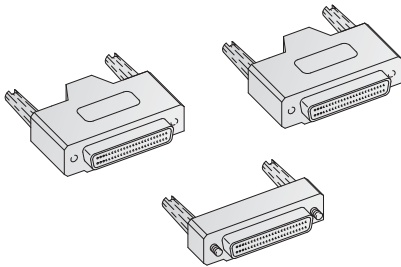

Connectors A6CON

The 40-pin connectors are available in four different connection versions that differ in the way the leads are connected.

These connectors are required for all modules that connect to external signals via a 40-pin plug connection.

Whilst for the connectors A6CON-1 to A6CON-3 the cable is attached straight into the connector, in the case of the A6CON-4 the lead is angled.

Specifications		A6CON-2	A6CON-3	A6CON-4
Connector		Crimp-contact type	Pressure displacement type	Soldering type
Applicable wire size	mm <sup>2</sup>	0.3	0.3	0.3
Order information	Art. no	134140	134141	146923

4 Connection Cables with Connectors

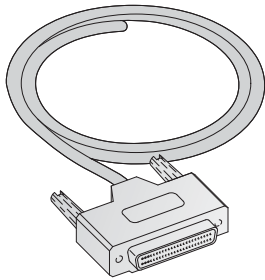

Assembled cables

The cables Q40CBL-3M and Q40CBL-5M serve as connecting cables for I/O modules with 40-pin plug connection.

The cables are prefabricated, i.e. a 40-pin connector is already attached to one cable end.

The cables FA-CBLQ75M□□ are ready made cables for the connection of the positioning modules QD75D1/D2/D4 or QD75P1/P2/P4 to a Mitsubishi servo amplifier MR-J2-Super or MR-C .

Specifications		Q40CBL-3M	Q40CBL-5M	Q40CBL-10M	FA-CBLQ75M2J2-P	FA-CBLQ75M2C-P	FA-CBLQ75PM2J2	FA-CBLQ75PM2C
Application range		All System Q modules with 40-pin connectors, like e.g. QX71, QX72, QY41P, QY42P			QD75D1/D2/D4 for connection with MELSERVO MR-J2-S	QD75D1/D2/D4 for connection with MELSERVO MR-C	QD75P1/P2/P4 for connection with MELSERVO MR-J2-S	QD75P1/P2/P4 for connection with MELSERVO MR-C
Specifications	m	3.0	5.0	10.0	2.0	2.0	2.0	2.0
Order information	Art. no.	140991	140997	158068	147697	147698	147699	147700

Memory Cards



MELSEC System Q memory cards

All System Q CPUs have a permanently installed RAM. This memory can be extended with a variety of external memory cards.

Specifications		Q2MEM-1MBS	Q2MEM-2MBS	Q2MEM-2MBF	Q2MEM-4MBF	Q2MEM-8MBA	Q2MEM-16MBA	Q2MEM-32MBA
Memory	type	SRAM	SRAM	Flash	Flash	ATA	ATA	ATA
Memory capacity		1 MB	2 MB	2 MB	4 MB	8 MB	16 MB	32 MB
Order information	Art. no.	127627	145399	127591	129646	129647	129648	129649

Specifications		Q3MEM-4MBS	Q3MEM-4MBS-SET	Q3MEM-8MBS	Q3MEM-8MBS-SET
Memory	type	SRAM	SRAM	SRAM	SRAM
Memory capacity		4 MB	4 MB	8 MB	8 MB
Order information	Art. no.	217621	217622	217623	217624

## PCMCIA Adapter Unit

### Memory card adapter

The memory card adapter Q2MEM-ADP is used for the PCMCIA slot of the PLC for data transferring.

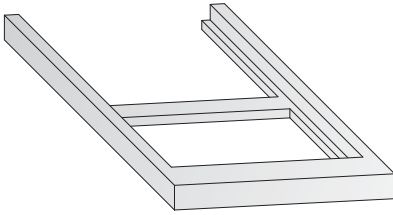

Specifications		Q2MEM-ADP
For memory cards	type	All MELSEC Q memory cards
Order information		Art. no. 129650

## Battery Q2MEM-BAT

### Memory card buffer battery

The lithium battery Q2MEM-BAT is a replacement battery for the SRAM memory card Q2MEM-1MBS.



Specifications		Q2MEM-BAT
For memory card	type	Q2MEM-1MBS and Q2MEM-2MBS
Voltage	V DC	3.0
Capacity	mAh	48
Order information		Art. no. 129854

## Battery Q6BAT

### Buffer battery

The lithium battery Q6BAT is the replacement for the battery integrated for data backup in any MELSEC System Q CPU.

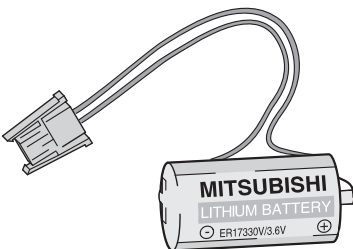

Specifications		Q6BAT
Voltage	V DC	3.0
Capacity	mAh	1800
Dimensions (ØxH)	mm	Ø16x30
Order information		Art. no. 130376



**DIN Rail Mounting Adapter**

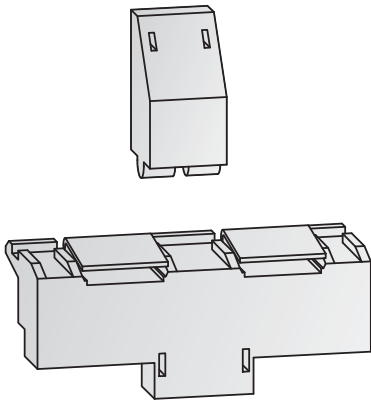

**Adapter for mounting a MELSEC System Q on a DIN rail**

The mounting adapter is used for easy and quick mounting the MELSEC Q base units on a DIN rail.

Specifications	Q6DIN1	Q6DIN2	Q6DIN3
For base units	Q38B/Q312B/Q68B/Q612B	Q35B/Q65B	Q33B/Q63B
Dimensions (WxH)	mm 328x98	245x98	198x98
<b>Order information</b>	Art. no. 129673	129674	136368

4 ACCESSORIES

**Interchangeable Terminal Blocks for I/O Modules**

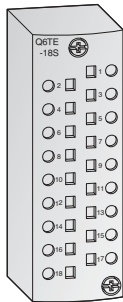

**Terminal blocks for screw-less wiring**

As an alternative to the standard screw terminal blocks for the input/output modules, there are two different screw-less terminal blocks available. The spring clamp terminal block Q6TE-185 permits the connection of single or multiple-wire copper conductors, whereby the stripped cable ends are pressed vertically

into the terminal and are held by a traction spring. In the case of the Q6TA32 terminal block, contact is made by pressing in the wire with the optional insertion tool without having to strip the wire first. This allows for rapid wiring of the terminals.

Specifications	Q6TE-185	Q6TA32
Type	Spring clamp terminal block	IDC terminal block adapter
Applicable modules	All System Q modules with terminal block for 18 screw terminals	QX41, QX71, QY41P, QY71
Applicable wire size	mm <sup>2</sup> 0.3–1.5	0.5
Weight	kg 0.07	0.08
<b>Order information</b>	Art. no. 141646	145034
Accessory	—	Insertion tool Q6TA32TOL, art. no.: 145035

**Extension Device Box**

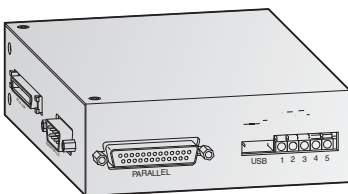

**Extension by additional interfaces**

Each extension device box extends the PC-CPU by one RS232, one USB, and one parallel interface. Furthermore, additional potential free remote contacts are included which support e.g. the polling of the watchdog timer or a remote shutdown.

The extension device box is connected to the "EX I/F" connector on the front panel of the CPU module.

Specifications	PPC-COT-01	PPC-DINAD-01
Type	Interface extension box	DIN-rail mounting adapter for the extension device box
Interface	1 x RS232, 1 x USB, 1 x parallel	
<b>Order information</b>	Art. no. 139819	140127

## Memory Media for Q-PC

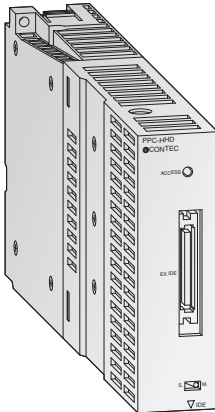

### Memory units

8 different disk drives are available for the Q-PC that can be inserted additionally into the base unit directly beside the CPU module. The connection to the CPU is established via a short cable link underneath the modules.

Besides a conventional hard disk with a storage capacity of 5 GB a number of so called silicon disks for the use under ambient conditions subject to strong vibrations or shocks is available.

Specifications	PPC-HDD (MS)A	PPC-CF-1GB-R
Type	Hard disk	CF Card
Memory capacity	20 GB	1 GB
<b>Order information</b>	Art. no. 207879	207880
Accessories	Hard disk vibration protection PPC-HBR-01; art. no.: 140126	

## External Drive for Q-PC

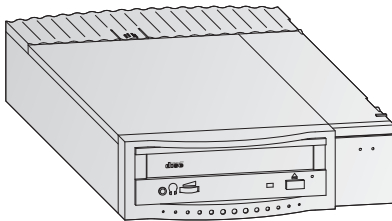

### Disk drives

For the Q-PC a special external floppy disk drive and a special CD-ROM drive are available.

The drives provide their own casing and are connected to the Q-PC via cable.

Specifications	PPC-IPC-CDD-02
Type	CD/DVD-ROM
Description	External drive incl. cable
<b>Order information</b>	Art. no. 207881

## Cable

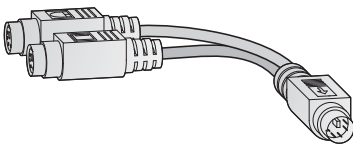

If both, mouse and keyboard are intended to be connected at the same time, the Y-adaptor PPC-YCAB-01 is required.

The cable PPC-SCC-01 extends the Q-PC by one serial interface.

Specifications	PPC-YCAB-01	PPC-SCC-01
Type	Mouse and keyboard cable	Cable for 2nd serial interface
Design	PS/2 Y cable	EX/IF connection to 9-pin D-Sub
<b>Order information</b>	Art. no. 140484	139820

■ Base Units

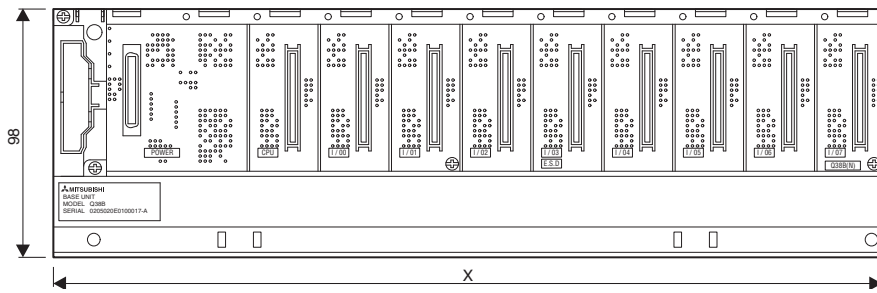

Type	X (in mm)
Q32SB	114
Q33B	189
Q33SB	142
Q35B	245
Q35SB	197.5
Q38B/Q38DB	328
Q312B/Q312DB	439
Q52B	106
Q55B	189
Q63B	189
Q66B	245
Q68B	328
Q612B	439

■ Base Units (with redundant power supply)

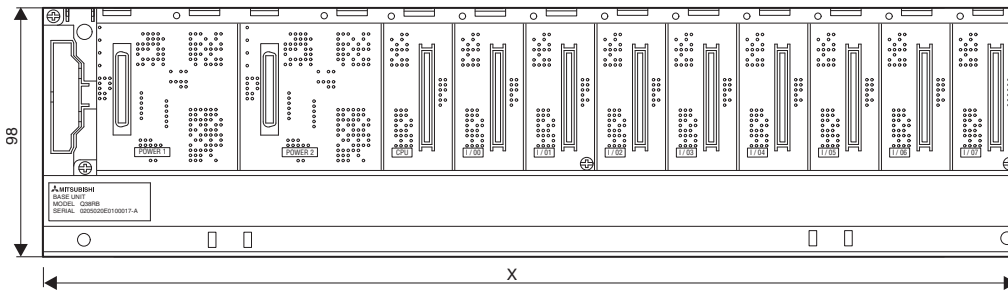

Type	X (in mm)
Q38RB	439
Q68RB	439
Q65WRB	439

■ CPUs and Power Supply Modules

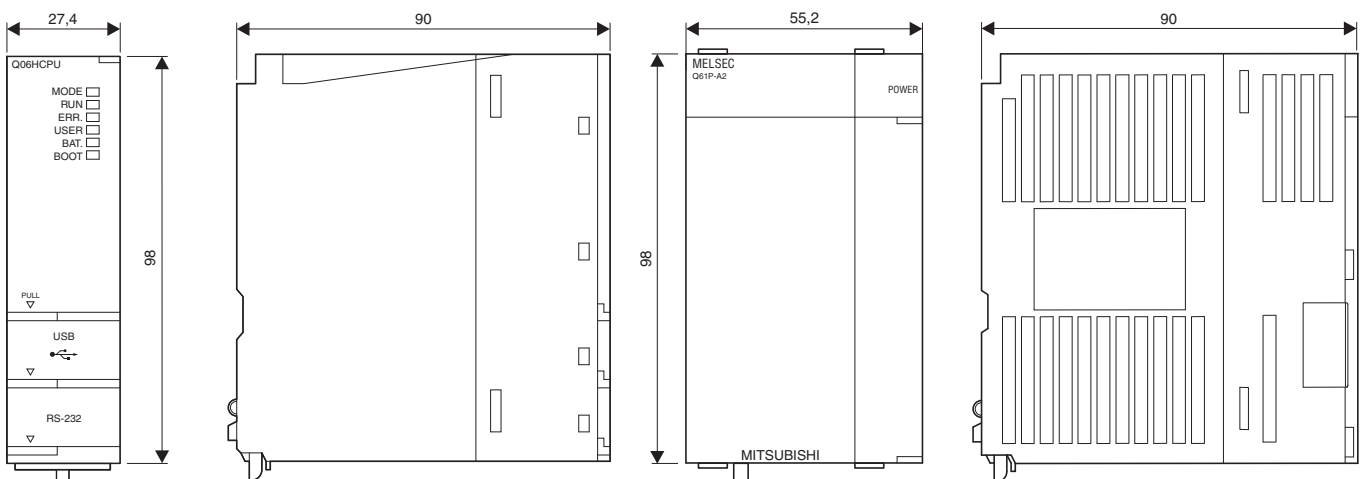

Unit: mm

■ Safety Main Base Unit

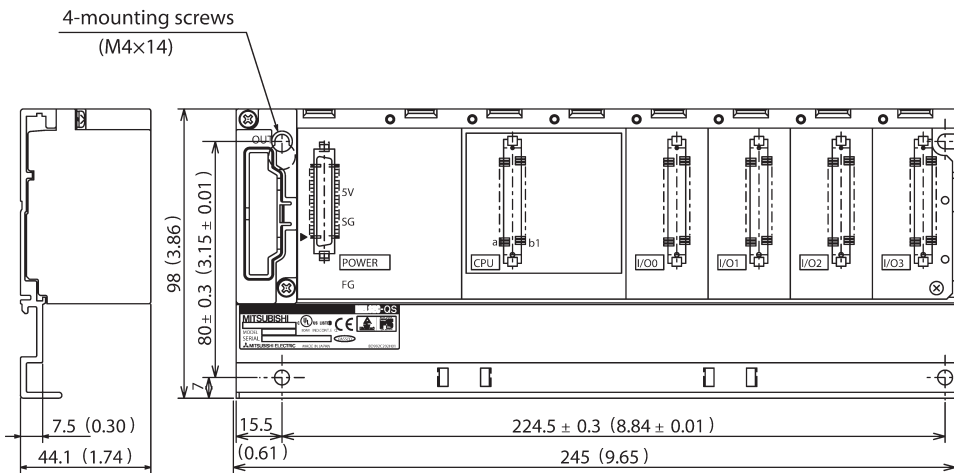

Type	X (in mm)
QS034B-E	245

Unit: mm

■ Safety CPU and Power Supply Module

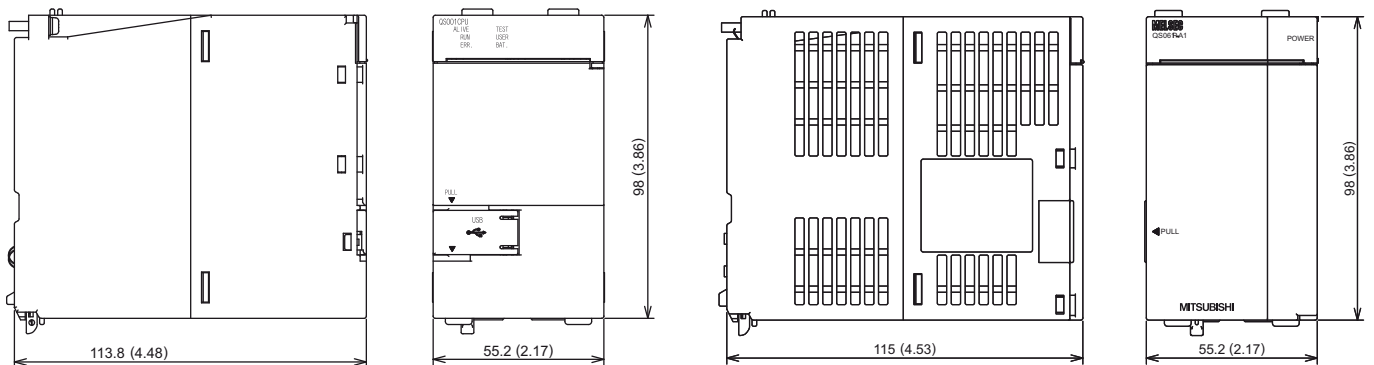

Unit: mm

■ CPUs and Power Supply Modules (redundant)

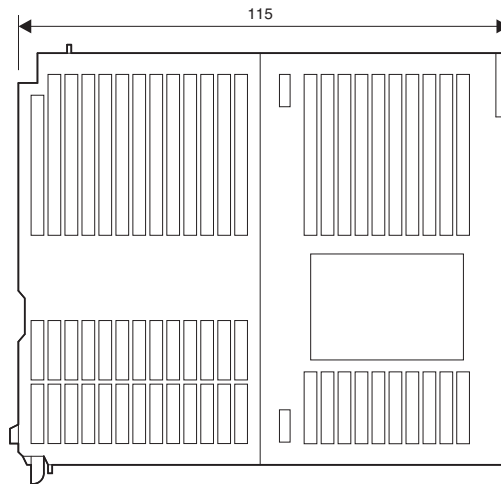
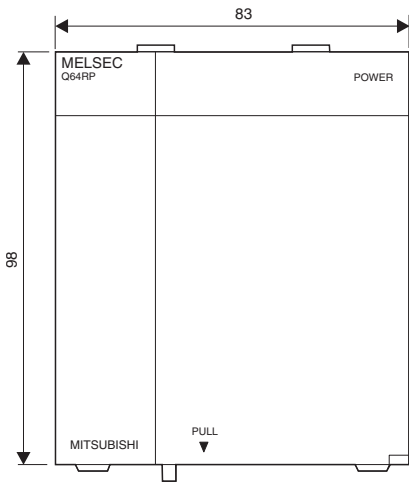
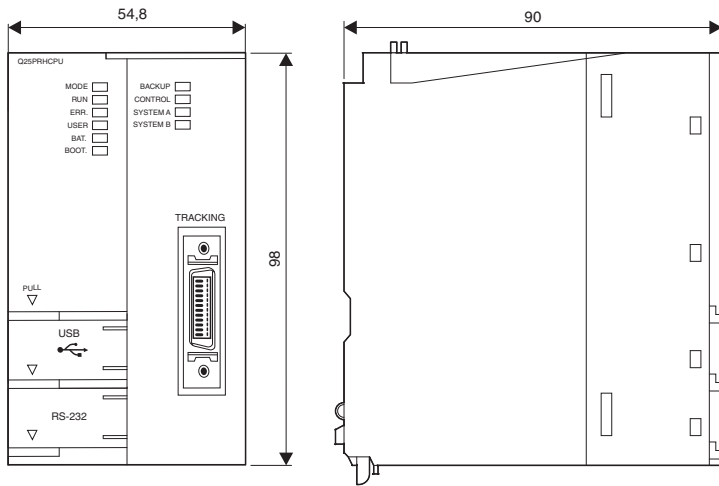

Unit: mm

■ I/O Modules and Special Function Modules

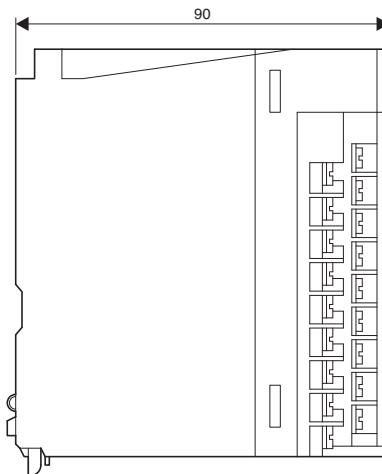
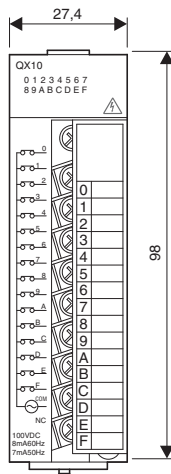
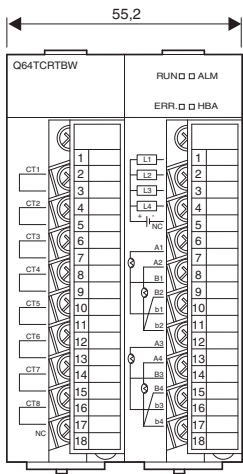

Unit: mm

5 DIMENSIONS

■ Terminal Block Adapters

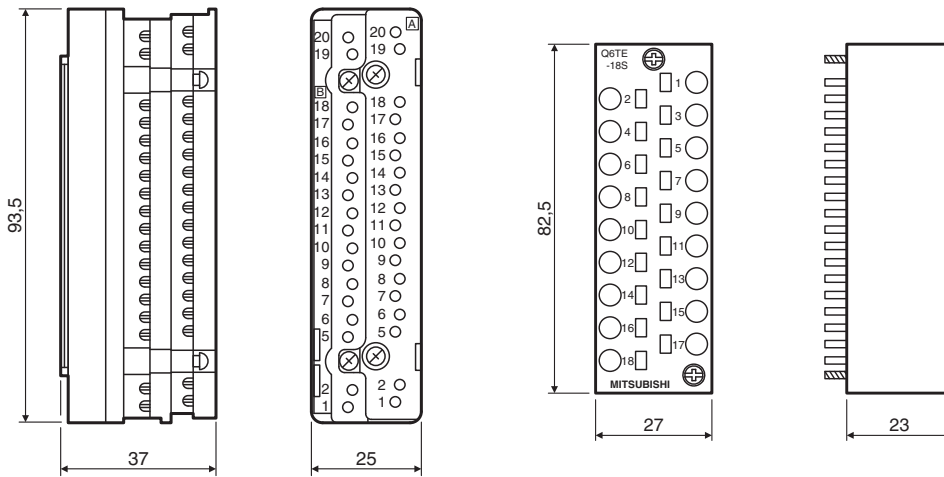

Unit: mm

■ Connectors

A6CON2

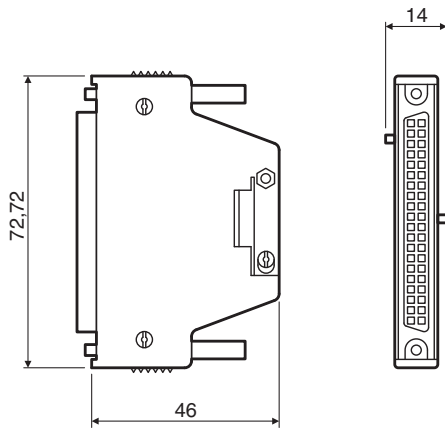

A6CON4

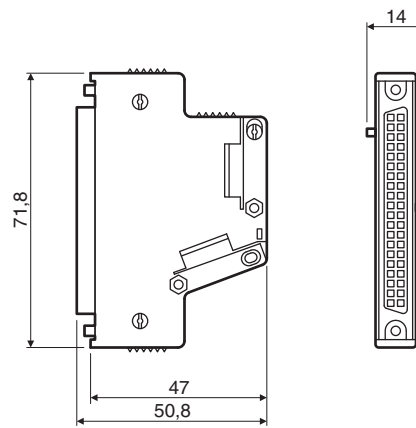

A6CON3

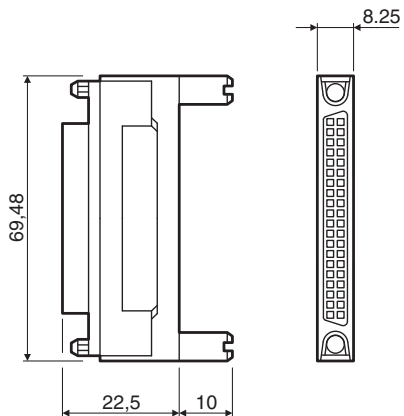

Unit: mm



## MELSOFT – Programming and Documentation Software for Standard Personal Computers



With the MELSOFT software family Mitsubishi Electric offers efficient software packages helping to reduce programming and setup times to a high degree.

The MELSOFT software family provides instant access, direct communications, compatibility, and open exchange of variables.

The MELSOFT family comprises:

- Programming packages like GX Developer and GX IEC Developer
- Network configuration software like for example GX Configurator DP
- Visualization software like for example MX Scada
- Software for a dynamic data exchange like MX Change
- Various development software for operator terminals (please refer to the Brochure HMI Family)

GX Developer is recommended as a costeffective beginners package for the MELSEC System Q. This package offers a quick and easy introduction to programming.

For structured programming the IEC 1131 (EN 61131) conform programming software GX IEC Developer is recommended.

For detailed information please order our separate MELSOFT brochure.

### ■ GX Developer

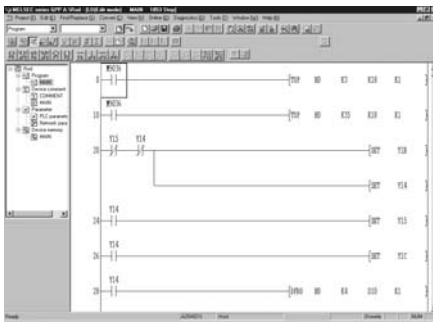

GX Developer is the standard programming software for all MELSEC PLC series with the user guidance of Microsoft Windows.

With this software you can comfortably create PLC programs alternatively in the form of Ladder Diagrams or Instruction Lists. Both forms of representation can be toggled easily during operation.

Besides efficient monitoring and diagnostics functions GX Developer features an offline simulation of any PLC type.

With GX Developer all MELSEC PLCs from the FX1S to the Q25H are supported. The

use of GX Developer FX is limited to the PLCs of the FX family.

This software provides all the Windows-specific advantages and is especially suited to all MELSEC PLCs.

GX Developer can be run under MS Windows® XP and Vista.

The software is supplied without a programming cable, which has to be ordered separately if required and which is used for the connection between the PLC and a serial interface of a personal computer.

Software	GX Developer V0800-1LOC-G	GX Developer V0800-1LOC-E	PX Developer V0100-1LOC-E
Series	All MELSEC PLCs	All MELSEC PLCs	Optional for process CPUs in combination with GX Developer
Language	German	English	English
<b>Order information</b>	Art. no. 152816	150420	162370
Accessories	Programming cable QC30R2, art. no.: 128424; QC30-USB, art. no.: 136577		

### ■ GX IEC Developer

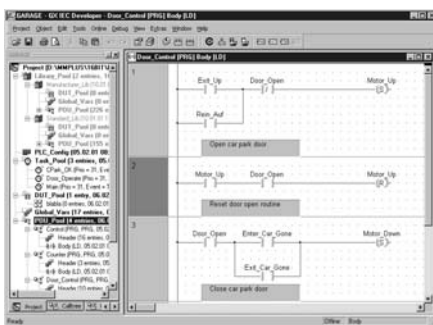

GX IEC Developer provides all functions of the pre-mentioned programs and in addition meets the programming standard for the future: IEC 1131.3 (EN 61131). This makes the software ready for the programming standard of the future and offers as a basis for the on-leading programming of the MELSEC A and MELSEC system Q.

GX IEC Developer can be run under MS Windows® XP and Vista.

The software is supplied without a programming cable, which has to be ordered separately if required and which is used for the connection between the PLC and a serial interface of a personal computer.

Software	GX IEC DEVELOPER V0704-1LOC-G	GX IEC DEVELOPER V0704-1LOC-E
Series	All MELSEC PLCs	All MELSEC PLCs
Language	German	English
<b>Order information</b>	Art.-Nr. 230801	230836
Accessories	Programming cable QC30R2, art. no.: 128424; QC30-USB, art. no.: 136577	

## Software for Process Visualisation and for Dynamic Data Exchange

### ■ MX Change

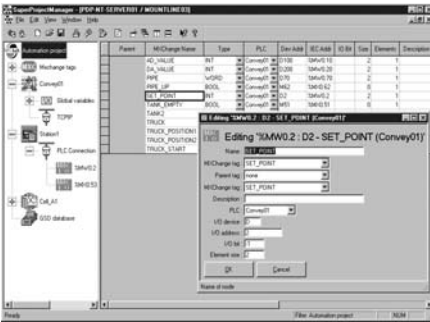

MX Change is integrated in the MELSOFT family as the "heart of automation". The software package consists of a Server and a Super Projekt Manager, other automation programs can be connected to. Since MX Change operates across a network, any variable once declared can be used by all other systems connected to the database.

Through this method following the principle "define once and use anywhere" the development time can even be decreased drastically.

MX Change can be run under MS Windows® XP and Vista.

Software	MX Change V0300-1LOC-E	MX Change V0300-1LOC-E-UPD
Language	English	English
Disk type	CD ROM	CD ROM
<b>Order information</b>	Art. no. 168915	168916

### ■ MX OPC Server

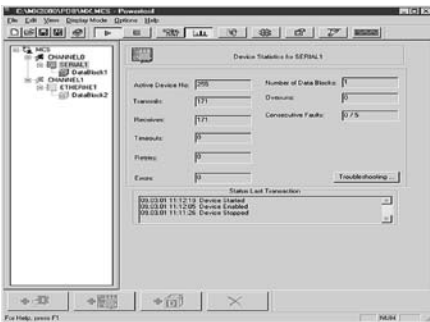

The OPC standard was developed for manufacturer independent communications between processes and Microsoft Windows® applications in client/server architecture.

OPC means "OLE for Process Control" and represents an application of the Microsoft DCOM technology (Distributed Component Object Model). In contrast to Active-X the OPC based data exchange especially features a higher performance.

The MX OPC server is a standardized software interface that enables Microsoft Windows® applications to access a Mitsubishi PLC quick and easily.

MX OPC Server can be run under MS Windows® XP and Vista.

Software	MX OPC Server V0600-1LOC-E
Series	All MELSEC PLCs
Language	English
Disk type	CD ROM
<b>Order information</b>	Art. no. 221608

### ■ MX Components

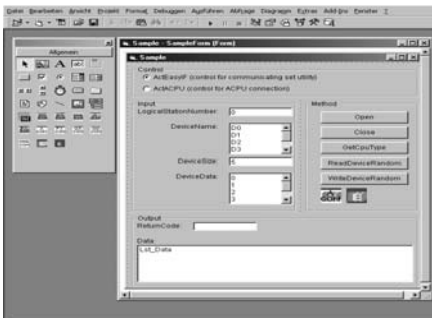

This software provides you with powerful Active-X elements. An internal driver manages the complete communications between your Microsoft Windows application and your process. Via MX components and a programming language (e.g. Visual Basic, Visual C++, etc.) you can easily create your own PC applications or integrate existing PC applications.

Moreover, via MX Components and VBA the complete MS Office range is at your service. Without high effort you can integrate online process data of a Mitsubishi PLC in your existing office software (e.g. MS Access or MS Excel etc.).

MX Components can be run under MS Windows® XP and Vista.

Software	MX Components V0300-1LOC-E
Series	All MELSEC PLCs
Language	English
Disk type	CD ROM
<b>Order information</b>	Art. no. 145309

Software for PROFIBUS Networks

**■ GX Configurator DP**



The Software GX Configurator DP is a user friendly configurations software for the open network PROFIBUS/DP.

The software package is a 32 bit application and runs under MS Windows® XP and Vista. Configuration of all PROFIBUS modules for the System Q, AnSH/QnAS series and also the FX family is possible.

Due to the supported extended user parameters of a GSD file, easy parameter setting of PROFIBUS/DP slave devices is possible even for third party devices.

The new GX Configurator DP enables the download of all configuration data via an overriding network.

Software		GX Configurator DP V07-1LOC-M	
Supported Profibus/DP master modules for the Mitsubishi MELSEC series		A1S/J71PB92D, QJ71PB92D, QJ71PB92V	
Language		English/German	
Version		7.04	
Order information		Art. no.	231731
Accessories		Programming cable QC30R2, art. no.: 128424; QC30-USB, art. no.: 136577	

Coming soon: iQ Works

iQ Works integrates the functions necessary to manage every part of the system cycle.

**System design**

The intuitive system configuration diagram allows for the graphic assembly of systems, centralized management of disparate projects and batch configuration of the entire control system.

**Programming**

Use system labels to seamlessly share device data between GOTs, PLCs and motion controllers. Save the time and hassle of changing device values in each program by using the update system labels feature.

**Test and startup**

Debug and optimize programs using the simulation functions. Use the included diagnostics and monitoring functions to quickly identify the source of errors.

**Operation and maintenance**

Speed up the process of commissioning, configuring and updating the system by using the batch read feature. Virtually eliminate the confusion associated with system management.

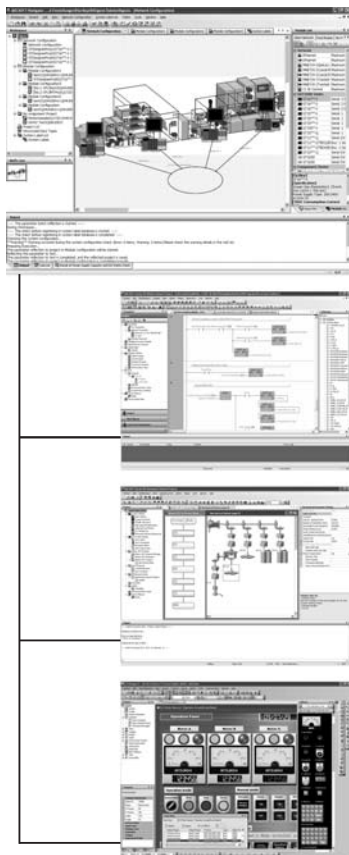

**MELSOFT Navigator**

is the heart of iQ Works. It enables the effortless design of entire upper-level systems and seamlessly integrates the other MELSOFT programs included with iQ Works. Functions such as system configuration design, batch parameter setting, system labels and batch read all help to reduce TCO.

**MELSOFT GX Works2**

represents the next generation in MELSOFT PLC maintenance and programming software. Its functionality has been inherited from both GX and IEC Developer, with improvements made throughout to increase productivity and drive down engineering costs.

**MELSOFT MT Works2**

is a comprehensive motion CPU maintenance and program desing tool. Its many useful functions, such as intuitive settings, graphical programming and digital oscilloscope, simulator, different Motion OS support, assistance help, to reduce the TCO associated with motion systems.

**MELSOFT GT Works3**

is a complete HMI programming, screen creation and maintenance program. In order to reduce the labor required to create detailed and impressive applications, the software's functionality has been built around the concepts of ease of use, simplifications (without sacrificing functionality) and elegance (in design and screen graphics).

<b>A</b>		<b>D</b>		<b>M</b>	
Accessories .....	50	Dimensions .....		MES Interface Module .....	47
Adapter .....	54	Adapters .....	59	QJ71MES96 .....	47
Analog Modules .....		Base Units .....	56	Memory Cards .....	52
ME1AD8HAI-Q .....	31	Connectors .....	59	Memory Media .....	55
Q62AD-DGH .....	31	Device Box .....	54	Motion CPU Modules .....	24
Q62DA-FG .....	32	Digital Modules .....	26	Q172CPUN .....	24
Q62DAN .....	32	QX10 .....	26	Q172DCPU .....	24
Q64AD .....	30	QX10-TS .....	26	Q172HCPU .....	24
Q64AD-GH .....	31	QX28 .....	26	Q173CPUN .....	24
Q64DAN .....	32	QX40 .....	26	Q173DCPU .....	24
Q64RD .....	33	QX40-TS .....	26	Q173HCPU .....	24
Q64RD-G .....	33	QX41 .....	26		
Q64TD .....	33	QX42 .....	26	<b>N</b>	
Q64TDV-GH .....	33	QX50 .....	27	Network Modules .....	45
Q66AD-DG .....	31	QX80 .....	27		
Q66DA-G .....	32	QX80-TS .....	27	<b>P</b>	
Q68AD-G .....	31	QX81 .....	27	PC CPU Module .....	22
Q68ADI .....	30	QX82-S1 .....	27	PPC-CPU 852(MS)-512 .....	22
Q68ADV .....	30	QY10 .....	28	PCMCIA Adapter Unit .....	53
Q68DAIN .....	32	QY10-TS .....	28	PLC CPU Modules .....	17
Q68DAVN .....	32	QY18A .....	28	Q00CPU .....	17
Q68RD3-G .....	33	QY22 .....	28	Q00JCPU-E .....	17
Q68TD-G-H01/H02 .....	33	QY40P .....	28	Q00UCPU .....	19
		QY40P-TS .....	28	Q00UJCPU .....	19
<b>B</b>		QY41P .....	28	Q01CPU .....	17
Base Units .....	14	QY42P .....	28	Q01UCPU .....	19
Q312B-E .....	14	QY50 .....	29	Q02CPU .....	18
Q312DB .....	14	QY68A .....	29	Q02HCPU .....	18
Q325B .....	14	QY80 .....	29	Q02PHCPU .....	20
Q33B-E .....	14	QY80-TS .....	29	Q02UCPU .....	19
Q335B .....	14	QY81P .....	29	Q03UDCPU .....	19
Q35B-E .....	14	Dummy Module .....	50	Q03UDECPU .....	19
Q355B .....	14	<b>E</b>		Q04UDEHCPU .....	19
Q38B-E .....	14	External Drive .....	55	Q04UDHCPU .....	19
Q38DB .....	14	<b>H</b>		Q06HCPU .....	18
Q38RB-E .....	14	High Speed Data Logger Module .....	48	Q06PHCPU .....	20
Q52B .....	15	QD81DL96 .....	48	Q06UDEHCPU .....	19
Q55B .....	15	High-Speed Counter Modules .....	37	Q06UDHCPU .....	19
Q612B .....	15	QD60P8-G .....	37	Q10UDEHCPU .....	19
Q63B .....	15	QD62 .....	37	Q10UDHCPU .....	19
Q65B .....	15	QD62D .....	37	Q12HCPU .....	18
Q65WRB .....	15	QD62E .....	37	Q12PHCPU .....	20
Q68B .....	15	QD63P6 .....	37	Q13UDEHCPU .....	19
Q68RB .....	15			Q13UDHCPU .....	19
QS034B-E .....	14	<b>I</b>		Q20UDEHCPU .....	19
Batteries .....	53	Interface Modules .....	43	Q20UDHCPU .....	19
<b>C</b>		QJ71C24N .....	43	Q25HCPU .....	18
C-Controller CPU .....	23	QJ71C24N-R2 .....	43	Q25PHCPU .....	20
Q06CCPU-V-H01 .....	23	QJ71C24N-R4 .....	43	Q26UDEHCPU .....	19
Q12DCCPU-V .....	23	QJ71MB91 .....	43	Q26UDHCPU .....	19
Cables .....		Interrupt Module .....	49	Pin Connectors .....	52
Adapter Cables .....	51	QI60 .....	49	Positioning Modules .....	40
Cable .....	55	QX40H .....	49	QD70P4 .....	38
Connection Cables with Connectors .....	52	QX70H .....	49	QD70P8 .....	38
Disconnection prevention .....	51	QX80H .....	49	QD72P3C3 .....	39
Programming Cable .....	51	QX90H .....	49	QD74MH16 .....	40
Tracking Cable .....	50			QD74MH8 .....	40
Communication Modules .....	44	<b>L</b>		QD75D1 .....	42
QD51 .....	44	Load Cell Input Module .....	35	QD75D2 .....	42
QD51-R24 .....	44	Q61LD .....	35	QD75D4 .....	42
		Loop Control Module .....	36	QD75M1 .....	42
		Q62HLC .....	36	QD75M2 .....	42

QD75M4 .....	42	<b>S</b>		<b>T</b>	
QD75MH1 .....	42	Safety CPU Module .....	25	Temperature Control Modules .....	34
QD75MH2 .....	42	QS001CPU .....	25	Q64TCRT .....	34
QD75MH4 .....	42	Software .....		Q64TCRTBW .....	34
QD75P1 .....	41	GX (IEC) Developer .....	60	Q64TCTT .....	34
QD75P2 .....	41	GX Configurator DP .....	62	Q64TCTTBW .....	34
QD75P4 .....	41	GX Developer .....	60	Terminal Blocks .....	54
Power Supply Modules .....	16	MX Change .....	61	<b>W</b>	
Q61P .....	16	MX Components .....	61	Web Server Module .....	46
Q61P-D .....	16	MX OPC Server .....	61	QJ71WS96 .....	46
Q61SP .....	16	iQ Works .....	62		
Q62P .....	16	System Description .....	4		
Q63P .....	16	Automation platform .....	4		
Q63RP .....	16	Configuration .....	10		
Q64PN .....	16	Equipment Features .....	5		
Q64RP .....	16	Expandability and performance .....	4		
QS061P-A1 .....	16	Module Combinations .....	11		
QS061P-A2 .....	16	Networks .....	12		
<b>R</b>		QS Safety programmable controller .....	7		
Redundant PLC CPU .....	21	Redundant CPU .....	8		
Q12PRHCPU .....	21	Task Management .....	6		
Q25PRHCPU .....	21	iQ Platform .....	7		



# A world of automation solutions

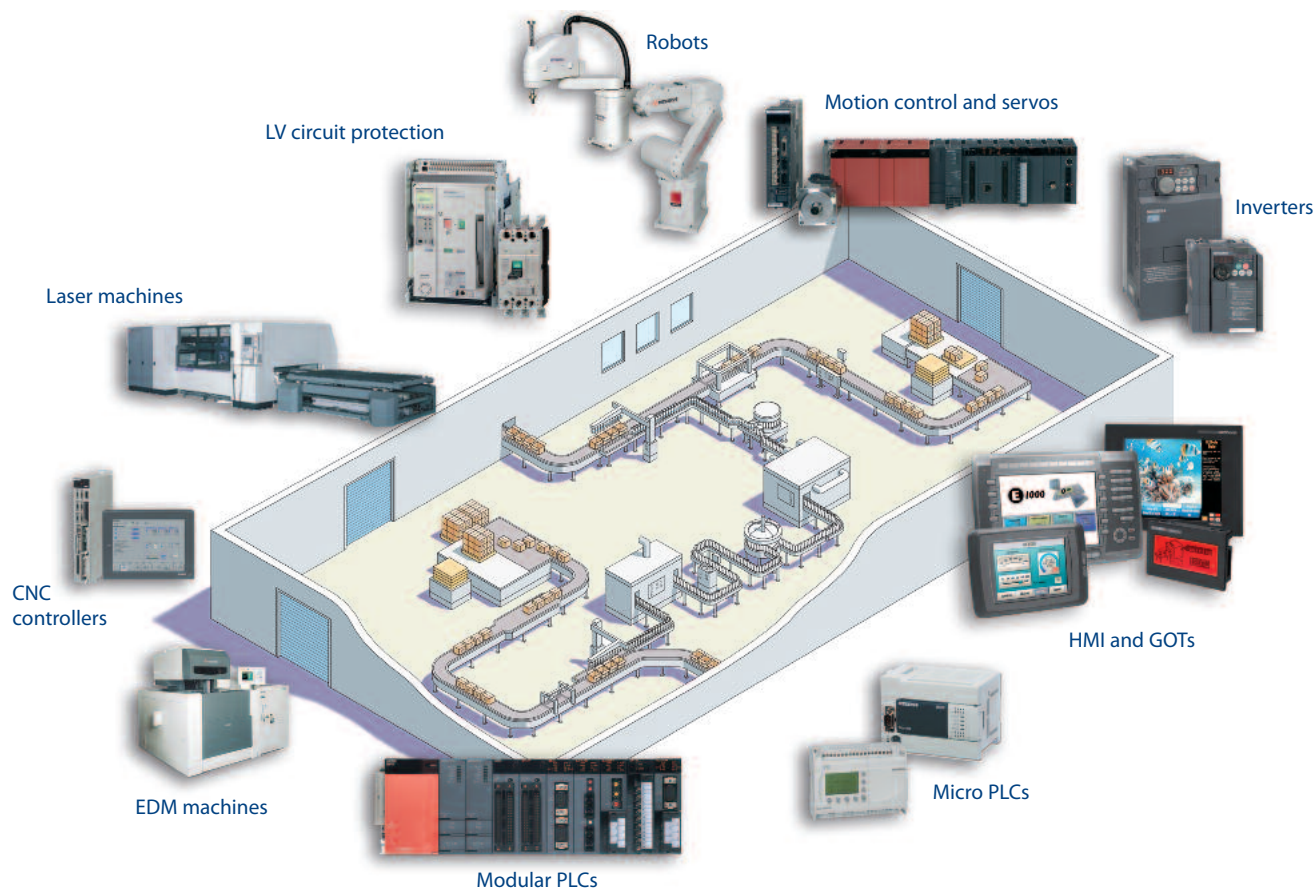

Mitsubishi offer a wide range of automation equipment from PLCs and HMIs to CNC and EDM machines.

## A name to trust

Since its beginnings in 1870, some 45 companies use the Mitsubishi name, covering a spectrum of finance, commerce and industry.

The Mitsubishi brand name is recognized around the world as a symbol of premium quality.

Mitsubishi Electric Corporation is active in space development, transportation, semiconductors, energy systems, communications and information processing, audio visual equipment, home electronics, building and energy management and automation systems, and has 237 factories and laboratories world-wide in over 121 countries.

This is why you can rely on a Mitsubishi automation solution – because we know first hand about the need for reliable, efficient, easy-to-use automation and control in our own factories.

As one of the world's leading companies with a global turnover of over 4 trillion Yen (over \$40 billion), employing over 100,000 people, Mitsubishi Electric has the resource and the commitment to deliver the ultimate in service and support as well as the best products.



# Global Partner. Local Friend.

## EUROPEAN BRANCHES

MITSUBISHI ELECTRIC EUROPE B.V. **GERMANY**  
Gothaer Straße 8  
**D-40880 Ratingen**  
Phone: +49 (0)2102 / 486-0

MITSUBISHI ELECTRIC EUROPE B.V. **CZECH REPUBLIC**  
Radická 714/113a  
**CZ-158 00 Praha 5**  
Phone: +420 (0)251 551 470

MITSUBISHI ELECTRIC EUROPE B.V. **FRANCE**  
25, Boulevard des Bouvets  
**F-92741 Nanterre Cedex**  
Phone: +33 (0)1 / 55 68 55 68

MITSUBISHI ELECTRIC EUROPE B.V. **ITALY**  
Viale Colleoni 7  
**I-20041 Agrate Brianza (MB)**  
Phone: +39 039 / 60 53 1

MITSUBISHI ELECTRIC EUROPE B.V. **POLAND**  
Krakowska 50  
**PL-32-083 Balice**  
Phone: +48 (0)12 / 630 47 00

MITSUBISHI ELECTRIC EUROPE B.V. **SPAIN**  
Canetera de Rubí 76-80  
**E-08190 Sant Cugat del Vallés (Barcelona)**  
Phone: 902 131121 // +34 935653131

MITSUBISHI ELECTRIC EUROPE B.V. **UK**  
Travellers Lane  
**UK-Hatfield, Herts. AL10 8XB**  
Phone: +44 (0)1707 / 27 61 00

## EUROPEAN REPRESENTATIVES

GEVA **AUSTRIA**  
Wiener Straße 89  
**AT-2500 Baden**  
Phone: +43 (0)2252 / 85 55 20

TEHNIKON **BELARUS**  
Oktyabrskaya 16/5, Off. 703-711  
**BY-220030 Minsk**  
Phone: +375 (0)17 / 210 46 26

ESCO D & A **BELGIUM**  
Culliganlaan 3  
**BE-1831 Diegem**  
Phone: +32 (0)2 / 717 64 30

Koning & Hartman b.v. **BELGIUM**  
Woluwealaan 31  
**BE-1800 Vilvoorde**  
Phone: +32 (0)2 / 257 02 40

INEA BH d.o.o. **BOSNIA AND HERZEG.**  
Aleja Lipa 56  
**BA-71000 Sarajevo**  
Phone: +387 (0)33 / 921 164

AKHNATON **BULGARIA**  
4 Andrij Ljapchev Blvd. Pb 21  
**BG-1756 Sofia**  
Phone: 902 131121 / 817 6004

INEA CR d.o.o. **CROATIA**  
Losinjska 4 a  
**HR-10000 Zagreb**  
Phone: +385 (0)1 / 36 940 - 01 / -02 / -03

AutoCont C.S. s.r.o. **CZECH REPUBLIC**  
Technologická 374/6  
**CZ-708 00 Ostrava-Pustkovec**  
Phone: +420 595 691 150

B.ELECTRIC, s.r.o. **CZECH REPUBLIC**  
Mladoboleslavská 812  
**CZ-197 00 Praha 19 - Kbely**  
Phone: +420 286 850 848

Bejler Electronics A/S **DENMARK**  
Lykkegårdsvej 17, 1.  
**DK-4000 Roskilde**  
Phone: +45 (0)46 / 75 76 66

Bejler Electronics Eesti OÜ **ESTONIA**  
Pärnu mnt. 160b  
**EE-11317 Tallinn**  
Phone: +372 (0)6 / 51 81 40

Bejler Electronics OY **FINLAND**  
Jaakonkatu 2  
**FIN-01620 Vantaa**  
Phone: +358 (0)207 / 463 500

UTECO A.B.E.E. **GREECE**  
5, Mavrogenous Str.  
**GR-18542 Piraeus**  
Phone: +30 211 / 1206 900

MELTRADE Ltd. **HUNGARY**  
Fertő utca 14.  
**HU-1107 Budapest**  
Phone: +36 (0)1 / 431 9276

KAZPROMAUTOM. Ltd. **KAZAKHSTAN**  
Mustafina Str. 7/2  
**KAZ-470046 Karaganda**  
Phone: +7 7212 / 50 11 50

Bejler Electronics SIA **LATVIA**  
Vestienas iela 2  
**LV-1035 Riga**  
Phone: +371 (0)784 / 2280

Bejler Electronics UAB **LITHUANIA**  
Savanoriu Pr. 187  
**LT-02300 Vilnius**  
Phone: +370 (0)5 / 232 3101

ALFATRADE Ltd. **MALTA**  
99, Paola Hill  
**Malta- Paola PLA 1702**  
Phone: +356 (0)21 / 697 816

INTEHISIS srl **MOLDOVA**  
bld. Traian 23/1  
**MD-2060 Kishinev**  
Phone: +373 (0)22 / 66 4242

HIFLEX AUTOM. B.V. **NETHERLANDS**  
Wolvenerstraat 22  
**NL-2984 CD Ridderkerk**  
Phone: +31 (0)180 - 46 60 04

Koning & Hartman b.v. **NETHERLANDS**  
Haarlerbergweg 21-23  
**NL-1101 CH Amsterdam**  
Phone: +31 (0)20 / 587 76 00

Bejler Electronics AS **NORWAY**  
Postboks 487  
**NO-3002 Drammen**  
Phone: +47 (0)32 / 24 30 00

Sirius Trading & Services **ROMANIA**  
Aleea Lacul Morii Nr. 3  
**RO-060841 Bucuresti, Sector 6**  
Phone: +40 (0)21 / 430 40 06

Craft Con. & Engineering d.o.o. **SERBIA**  
Bulevar Svetog Cara Konstantina 80-86  
**SER-18106 Nis**  
Phone: +381 (0)18 / 292-24-4/5

INEA SR d.o.o. **SERBIA**  
Izletnicka 10  
**SER-113000 Smederevo**  
Phone: +381 (0)26 / 617 163

AutoCont Control s.r.o. **SLOVAKIA**  
Radlinského 47  
**SK-02601 Dolny Kubin**  
Phone: +421 (0)43 / 5868210

CS Mirade Slovensko, s.r.o. **SLOVAKIA**  
Vajnaského 58  
**SK-92101 Piestany**  
Phone: +421 (0)33 / 7742 760

INEA d.o.o. **SLOVENIA**  
Stegne 11  
**SI-1000 Ljubljana**  
Phone: +386 (0)1 / 513 8100

Bejler Electronics AB **SWEDEN**  
Box 426  
**SE-20124 Malmö**  
Phone: +46 (0)40 / 35 86 00

Omni Ray AG **SWITZERLAND**  
Im Schörl 5  
**CH-8600 Dübendorf**  
Phone: +41 (0)44 / 802 28 80

GTS **TURKEY**  
Bayraktar Bulvarı Nutuk Sok. No:5  
**TR-34775 Yukari ISTANBUL**  
Phone: +90 (0)216 526 39 90

CSC Automation Ltd. **UKRAINE**  
4-B, M. Raskovoyi St.  
**UA-02660 Kiev**  
Phone: +380 (0)44 / 494 33 55

TEXEL ELECTRONICS Ltd. **ISRAEL**  
2 Ha'umanut, P.O.B. 6272  
**IL-42160 Netanya**  
Phone: +972 (0)9 / 863 39 80

CEG INTERNATIONAL **LEBANON**  
Cebaco Center/Block A Autostrade DORA  
**Lebanon - Beirut**  
Phone: +961 (0)1 / 240 430

CEI Ltd. **SOUTH AFRICA**  
Private Bag 2016  
**ZA-1600 Isando**  
Phone: +27 (0)11 / 977 0770



Mitsubishi Electric Europe B.V. /// FA - European Business Group /// Gothaer Straße 8 /// D-40880 Ratingen /// Germany  
Tel.: +49(0)2102-4860 /// Fax: +49(0)2102-4861120 /// info@mitsubishi-automation.com /// www.mitsubishi-automation.com

Specifications subject to change /// Art. no. 201288-B /// 03.2010

WWW.BSNEW.IR

All trademarks and copyrights acknowledged.