

Open Network for High-Speed Control

# CompoNet

- CompoNet Master Unit  
CS1W-CRM21/CJ1W-CRM21
- CompoNet Slave Unit  
CRT1 Series
- CompoNet Repeater Unit  
CRS1 Series

Fast and  
Intelligent

# CompoNet

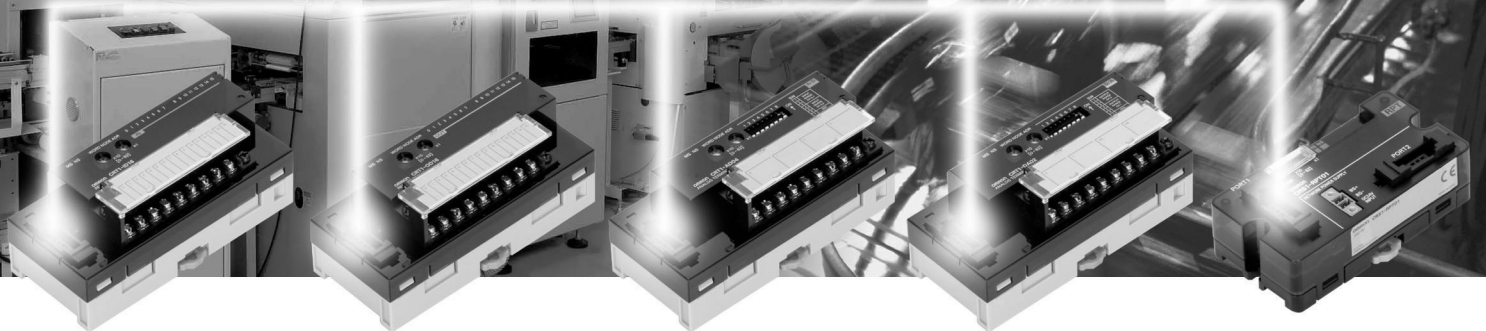

# realizing

# TABLE OF CONTENTS

<b>Communications Specifications</b> .....	<b>1</b>
<b>CS/CJ-series CompoNet Master Units (CS1W/CJ1W-CRM21)</b> .....	<b>3</b>
Ordering Information .....	3
Master Unit Specifications .....	4
Smart Functions .....	5
What Are Smart Functions? .....	7
<b>CompoNet Digital I/O Slave Units with Screw Terminal Blocks (2-tier Terminal Block/Relay Output/SSR Output) (CRT1-ID16(-1)/OD16(-1)/ROS16/ROF16)</b>	<b>10</b>
Ordering Information .....	10
Performance Specifications .....	11
Input Section Specifications .....	11
Output Section Specifications .....	12
<b>CompoNet Digital I/O Slave Units with Screw Terminal Blocks (3-tier Terminal Block) (CRT1-ID16TA(-1)/OD16TA(-1)/MD16TA(-1))</b> .....	<b>13</b>
Ordering Information .....	13
Performance Specifications .....	14
Input Section Specifications .....	14
Output Section Specifications .....	15
Input and Output Section Specifications .....	16
<b>CompoNet Digital I/O Slave Units with Connectors (CRT1-ID16S(-1)/OD16S(-1)/MD16S(-1))</b>	<b>17</b>
Ordering Information .....	17
Performance Specifications .....	17
Input Section Specifications .....	18
Output Section Specifications .....	18
Input and Output Section Specifications .....	19
<b>CompoNet Digital I/O Slaves with Clamp Terminals (CRT1-ID16SL(-1)/OD16SL(-1))</b> .....	<b>20</b>
Ordering Information .....	20
Performance Specifications .....	20
Input Section Specifications .....	21
Output Section Specifications .....	21
<b>CompoNet Analog I/O Slave Units (CRT1-AD04/DA02)</b> .....	<b>22</b>
Ordering Information .....	22
Performance Specifications .....	22
Input Section Specifications .....	23
Output Section Specifications .....	23
<b>Expansion Units (XWT-ID08(-1)/OD08(-1)/ID16(-1)/OD16(-1))</b> .....	<b>24</b>
Ordering Information .....	24
Performance Specifications .....	24
Input Section Specifications .....	25
Output Section Specifications .....	25
<b>CompoNet Bit Slave Units with Connectors (CRT1B-□D02S(-1)/□D02SP(-1)/ID04SP(-1))</b> ...	<b>26</b>
Ordering Information .....	26
Performance Specifications .....	27
Input Section Specifications .....	27
Output Section Specifications .....	28
<b>CompoNet Bit Slave Units with Clamp Terminal Blocks (CRT1B-MD04SLP(-1))</b> .....	<b>29</b>
Ordering Information .....	29
Performance Specifications .....	30
Input Section Specifications .....	30
Output Section Specifications .....	31
<b>CompoNet Repeater Unit (CRS1-RPT01)</b> .....	<b>32</b>
Ordering Information .....	32
Specifications .....	33
<b>Sensor Communications Unit (ZS-CRT)</b> .....	<b>34</b>
Ordering Information .....	34
Performance Specifications .....	34
<b>Appendix</b> .....	<b>35</b>
<b>Ordering Information</b> .....	<b>41</b>
<b>Related Manuals</b> .....	<b>46</b>

# Communications Specifications

Item	Specification
Communications protocol	CompoNet Network protocol
Types of communications	Remote I/O communications (programless, constant sharing of data with Slave Units) and message communications (explicit message communications as required with Slave Units and FINS message communications as required with PLCs)
Baud rate	4 Mbits/s (See note.), 3 Mbits/s, 1.5 Mbits/s, 93.75 kbits/s <b>Note:</b> Drop-line connections are not supported with a baud rate of 4 Mbits/s, so Slaves with prewired cables (Bit Slaves) cannot be used.
Modulation	Base-band
Coding	Manchester code
Error control	Manchester code rules, CRC
Communications media	The following media can be used. <ul style="list-style-type: none"> <li>• Round cable I (JIS C 3306, VCTF 2-conductor)</li> <li>• Flat Cable I (DCA4-4F10 Standard Flat Cable)</li> <li>• Flat Cable II (DCA5-4F10 Sheathed Flat Cable)</li> </ul> <b>Note:</b> Round cable I, Flat Cable I, and Flat Cable II are all different types of cable. To use more than one type of cable at a time, Repeater Units must be used to separate them on trunk lines and sub-trunk lines.
Communications distance and wiring	Refer to <i>Cable Types, Baud Rates, and Maximum Distances</i> on page 12 of <i>CompoNet Catalog</i> (Cat. No. R140).
Connectable Master Units	CompoNet Master Units
Connectable Slave Units	CompoNet Slave Units
Maximum I/O capacity	Word Slave Units: 1,024 inputs and 1,024 outputs (2,048 I/O points total) Bit Slave Units: 256 inputs and 256 outputs (512 I/O points total)
Maximum number of nodes	Word Slave Units: 64 input nodes and 64 output nodes Bit Slave Units: 128 input nodes and 128 output nodes Repeater Units: 64 nodes
Bits allocated per node address	Word Slave Units: 16 bits Bit Slave Units: 2 bits
Maximum number of nodes per trunk line or sub-trunk line	32 nodes (including Repeater Units)
Applicable node addresses	Word Slave Units: IN0 to IN63 and OUT0 to OUT63 Bit Slave Units: IN0 to IN127 and OUT0 to OUT127 Repeater Units: 0 to 63
Repeater Unit application conditions	Up to 64 Repeater Units can be connected per network. When Repeater Units are connected in series from the Master Unit, up to 2 extra segment layers can be created (i.e., up to 2 Repeater Units are allowed between a Slave Unit and the Master Unit).
Signal lines	Two lines: BDH (communications data high) and BDL (communications data low)
Power lines	Two lines: BS+ and BS- (power for communications and internal Slave Unit circuits) • Power is supplied from the Master Unit or Repeater Units.
Communications power supply	24 VDC $\pm$ 10%
Connection forms	Flat Cable at baud rate of 93.75 kbits/s: No restrictions Other cables or baud rates: Trunk line and branch lines Connections for Slave Units and Repeater Units: T-branch or multidrop connections
Remote I/O communications	Automatic startup when power is turned ON (See note.) or manual startup using the Remote I/O Communications Start Switch in I/O Communications Manual Start Mode. <b>Note:</b> When power is turned ON to the PLC and the Slave Unit communications power is turned ON. Communications are not started in the following cases: <ul style="list-style-type: none"> <li>• In Registered Slave Unit Participation Standby Mode, communications is not started until all registered Slave Units are participating in the network.</li> <li>• In Communications Error Communications Stop Mode, communications stop when a communications error occurs.</li> </ul>
I/O communications manual startup mode	I/O Communications Manual Startup Mode can be set from the CompoNet Support Software so that remote I/O communications are not started when the power is turned ON. Remote I/O communications will not start until the Remote I/O Communications Start Switch is turned ON in memory.
Communications error communications stop mode	All remote I/O communications are stopped if a communications error occurs in any Slave Unit. <b>Note:</b> Communications will not stop for verification errors for registration tables or duplicated address settings.
Communications error input data zero clear mode	All input data will be cleared to zeros in any Slave Unit in which a communications error occurs.

Item		Specification
Duplicated Slave address check		<p>If the same address is set for two different Slave Units or the same memory is allocated to two different nodes, the Slave Unit that joins communications last will cause a duplicated address error and will leave the network. The Duplicated Address Error Flag will turn ON.</p> <p><b>Note:</b> This error will also occur if a Slave Unit leaves the network and then a different type of Slave Unit joins the network.</p>
Registration table		<p>The Slave Units that can participate for each node address are registered in a table so that only the registered Slave Units can participate. If a different Slave Unit attempts to join the network, the Registration Table Verification Error Flag will turn ON. The Registration Table is generated automatically or manually edited from the CompoNet Support Software.</p>
Slave Unit status	Without registration table	<p>Participation Flag and Communications Error Flag for each Slave Unit</p> <ul style="list-style-type: none"> <li>• Participation Flag: Turns ON and remains ON if the Slave Unit joins the network even one time after system power is turned ON.</li> <li>• Communications Error Flag: Turns ON if the Slave Unit cannot communicate with the Master Unit for any reason after the Slave Unit has joined the network (i.e., if the Participation Flag is ON). (Turns OFF when the error is removed.)</li> </ul> <p>Duplicated Address Error Flags and Alarm Flags</p>
	With registration table	<ul style="list-style-type: none"> <li>• Participation Flags and Communications Error Flags for each node address for all Slave Units registered in the Registration Table</li> <li>• Registration Table Verification Error Flags</li> <li>• All Registered Slave Units Participating Flag</li> </ul> <p><b>Note:</b> The Registered Slave Unit Participation Monitoring Time can be set (verification error check timing). Registered Slave Unit Participation Standby Mode can be set. (Remote I/O communications will not start until all registered Slave Units are participating.)</p>

# CS/CJ-series CompoNet Master Units

# CS1W/CJ1W-CRM21

## CS/CJ-series CompoNet Master Units Increase the Range of Applicability of Sensors and Actuators.

The CS/CJ-series CompoNet Master Unit manages the CompoNet network, controls communications between the PLC and Slave Units, and handles I/O data and message data.

- Setup is simple. Make the master's mode settings and set the baud rate, and you're ready to go.
- Control up to 2,560 points and 384 nodes with one Master Unit.
- Intuitive memory mapping with separate areas for Word Slave Units and Bit Slave Units.
- Seven-segment display helps with startup and enables prompt detection of problems.
- Collect information from Slave Units using message communications, or use message communications to set parameters.
- Inherits the ease of use of the CompoBus/S.
- Flexible I/O allocations with software setting function.



### Ordering Information

Name	Specifications		Number of unit numbers allocated	Power consumption (A)			Model	Standards
	Types of communications	Maximum number of I/O points per Master Unit		5-V system	24-V system	26-V system		
CS1 Special I/O Unit	<ul style="list-style-type: none"> <li>• Remote I/O communications</li> <li>• Message communications</li> </ul>	Word Slave Units: 1,024 inputs and 1,024 outputs (2,048 I/O points total) Bit Slave Units: 256 inputs and 256 outputs (512 I/O points total)	1, 2, 4, or 8	0.4	/	---	CS1W-CRM21	CE, U1, UC1 (pending)
CJ1 Special I/O Unit	<ul style="list-style-type: none"> <li>• Remote I/O communications</li> <li>• Message communications</li> </ul>	Word Slave Units: 1,024 inputs and 1,024 outputs (2,048 I/O points total) Bit Slave Units: 256 inputs and 256 outputs (512 I/O points total)	1, 2, 4, or 8	0.4	---	/	CJ1W-CRM21	CE, U1, UC1 (pending)

### International Standards

- The standards indicated in the "Standards" column are those current for UL, CSA, cULus, NK, and Lloyd standards and EC Directives as of the end of October 2007. The standards are abbreviated as follows; U: UL, U1: UL Class I Division 2 Products for Hazardous Locations, C: CSA, UC: cULus, UC1: cULus Class I Division 2 Products for Hazardous Locations, CU: cUL, N: NK, L: Lloyd, and CE: EC Directive.
- Ask your OMRON representative for the conditions under which the standards were met.

## Master Unit Specifications

Item	Model	CS1W-CRM21	CJ1W-CRM21
Applicable PLC		All CS-series PLCs	All CJ-series PLCs
Unit classification		CS-series Special I/O Unit	CJ-series Special I/O Unit
Current consumption (Power supplied from PLC's Power Supply Unit)		400 mA max. at 5 VDC	
Communications power supply connector		One communications power supply connector for Slave Units and Repeater Units on the trunk line when using Flat Cable <b>Note:</b> The Master Unit does not required communications power.	
Communications power supply connector allowable current capacity		5 A max.	
Maximum number of mountable Master Units		One word number assigned: 80 Units Two word numbers assigned: 48 Units Four word numbers assigned: 24 Units Eight word numbers assigned: 12 Units	One word number assigned: 40 Units Two word numbers assigned: 40 Units Four word numbers assigned: 24 Units Eight word numbers assigned: 12 Units
Mounting location		According to CS/CJ-series Special I/O Unit specifications.	
Communications power ON/OFF monitoring		The ON/OFF status of the communications power supply can be detected at the communications power supply connector.	
Data stored in Master Unit (built-in EEPROM)		1) The following device parameters: <ul style="list-style-type: none"> <li>• Registration Table</li> <li>• Registration Table Check Type</li> <li>• Registered Slave Unit Participation Monitoring Time, Registered Slave Unit Participation Standby Mode, and Event Disable Setting</li> <li>• Software Settings Table</li> <li>• Communications Error Communications Stop Mode</li> <li>• Communications Error Input Data Zero Clear Mode</li> <li>• Network settings</li> </ul> 2) Part of error history (depends on type of error; mainly serious error related to communications stopping)	
Noise immunity		Conforms to IEC 61000-4-4 2 kV (applied to PLC power supply).	
Vibration resistance		10 to 61.2 Hz with single-amplitude of 0.1 mm, 61.2 to 150 Hz and 14.7 m/s <sup>2</sup> in X, Y, and Z directions for 80 min each (sweep time of 8 min × 10 sweeps = 80 min)	
Shock resistance		196 m/s <sup>2</sup> (3 times each in X, Y, and Z directions)	
Dielectric strength		500 VAC (between isolated circuits)	
Insulation resistance		20 MΩ min. (between isolated circuits)	
Ambient operating temperature		0 to 55°C	
Ambient operating humidity		10 to 90% (no condensation)	
Ambient operating atmosphere		No corrosive gases	
Storage temperature		-20 to 75°C	
Weight		190 g max. (Master Unit only)	130 g max. (Master Unit only)

**Smart Functions**

The Slave Units provide Smart Functions that powerfully aid in everything from building the system and initial system startup to preventive system maintenance. The Smart Functions include functions for monitoring the operation time, changes in operating values, and other values, as well as functions that provide warnings for maintenance based on ON/OFF counts, total operating time, and other counted values.

**■ CompoNet Slave Unit Functions**

Yes: Supported, ---: Not supported

Unit	Digital I/O Slave Units					
	2-tier Terminal Block			3-tier Terminal Block		
	CRT1-□D16(-1)		CRT1-ROS16 CRT1-ROF16	CRT1-□D16TA(-1)		
Function	Input Units	Output Units	Output Units	Input Units	Output Units	Input/Output Units
Operation Time Monitor	Yes					
Contact Operation Monitor	Yes					
Total ON Time Monitor	Yes					
Automatic Baud Rate Detection	Yes					
Unit Conduction Time Monitor	Yes					
Naming Units	Yes					
Naming Connected Devices	Yes					
Network Power Voltage Monitor	Yes					
I/O Power Status Monitor	Yes		---		Yes	
Communications Error History Monitor	Yes					
Input Filter	Yes	---	---	Yes	---	Yes
Communications Error Output	---	Yes	Yes	---	Yes	Yes
Preventing Malfunctions Caused by Inrush Current at I/O Startup	Yes	---	---	Yes	---	Yes
Sensor Power Short-circuit Detection	---					
External Load Short-circuit Detection	---					
Removable Terminal Block Structure	Yes					
Expansion Using Expansion Units	Yes		Yes		---	
Scaling	---					
Last Maintenance Date	Yes					
Cumulative Counter	---					
Moving Average	---					
Setting the Number of AD Conversion Points	---					
Rate of Change	---					
Comparator	---					
Peak/Bottom Hold	---					
Top/Valley Hold	---					
Disconnected Line Detection	---					
User Adjustment	---					

Yes: Supported, ---: Not supported

Function	Unit		Digital I/O Slave Units				Analog I/O Slave Units		Bit Slave Units					Repeater Units
			Connector		Clamp Terminals									
	CRT1-□D16S(-1)			CRT1-□D16SL(-1)		CRT1-AD04 CRT1-DA02		CRT1B-□D02S(-1)		CRT1B-□D0□SP(-1) CRT1B-MD04SLP(-1)			CRS1-RPT01	
	Input Units	Output Units	Input/Output Units	Input Units	Output Units	Input Units	Output Units	Input Units	Output Units	Input Units	Output Units	Input/Output Units		
Operation Time Monitor	Yes				---		Yes					---		
Contact Operation Monitor	Yes				---		Yes					---		
Total ON Time Monitor	Yes				---		Yes					---		
Automatic Baud Rate Detection	Yes				Yes		Yes					Yes		
Unit Conduction Time Monitor	Yes				Yes		Yes					Yes		
Naming Units	Yes				Yes		Yes					Yes		
Naming Connected Devices	Yes				Yes		Yes					---		
Network Power Voltage Monitor	Yes				Yes		Yes					Yes		
I/O Power Status Monitor	---	Yes		Yes		---		---					---	
Communications Error History Monitor	Yes				Yes		Yes					Yes		
Input Filter	Yes	---	Yes	Yes	---	---		Yes	---	Yes	---	Yes	---	
Communications Error Output	---	Yes	Yes	---	Yes	---	Yes	---	Yes	---	Yes	Yes	---	
Preventing Malfunctions Caused by Inrush Current at I/O Startup	Yes	---	Yes	Yes	---	---		Yes	---	Yes	---	Yes	---	
Sensor Power Short-circuit Detection	---				---		Yes		---	Yes	---	Yes	---	
External Load Short-circuit Detection	---				---		---		Yes	---	Yes	---	Yes	
Removable Terminal Block Structure	---			Yes		Yes		---					---	
Expansion Using Expansion Units	---				---		---					---		
Scaling	---				Yes		---					---		
Last Maintenance Date	Yes				Yes		Yes					Yes		
Cumulative Counter	---				Yes		---					---		
Moving Average	---				Yes		---	---					---	
Setting the Number of AD Conversion Points	---				Yes		---	---					---	
Rate of Change	---				Yes		---	---					---	
Comparator	---				Yes		---	---					---	
Peak/Bottom Hold	---				Yes		---	---					---	
Top/Valley Hold	---				Yes		---	---					---	
Disconnected Line Detection	---				Yes		---	---					---	
User Adjustment	---				Yes		---					---		

**Note:** The Contact Operation Monitor and the Total ON Time Monitor cannot be used at the same time for the same contact.



## What Are Smart Functions?

### Smart Functions

#### Network Power Voltage Monitor

The Network Power Voltage Monitor function stores the present value, minimum value, and maximum value of the network power voltage in the Slave Unit memory. If a monitor voltage is set using the CompoNet Support Software, the monitor voltage is stored in the Slave Unit memory. (The default is 14 V.) If the voltage drops below the monitor voltage, a flag in a status area in the Slave Unit will turn ON to notify the Master Unit.

#### Unit Conduction Time Monitor

The cumulative time that power is ON to the Slave Unit's internal circuits can be stored in the Slave Unit memory. (This data can be read using the CompoNet Support Software or using explicit messages.)

The monitor value is also stored in the Slave Unit memory so once the total time reaches the monitor value, a flag in a status area in the Slave Unit turns ON to notify the Master Unit.

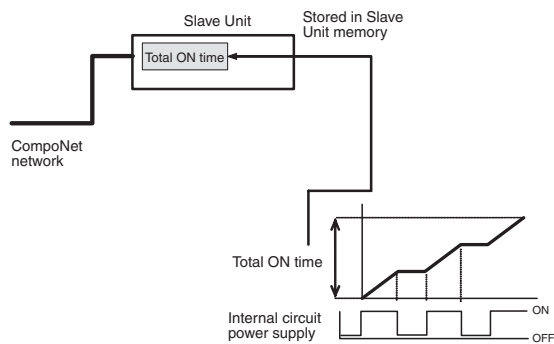

#### Naming Units

The user can set any name for each Unit (up to 32 characters) as a comment. The name is stored in the Slave Unit memory.

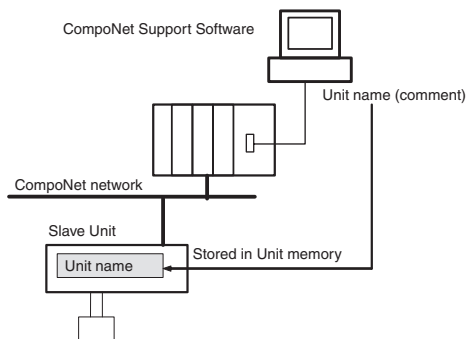

#### Naming Connected Devices

The user can set any name for each I/O contact in the Unit (up to 32 characters).

These names are stored in the Slave Unit memory. Connected devices can be checked for each I/O contact, which is useful for remote maintenance and other applications where, for example, devices with errors need to be identified.

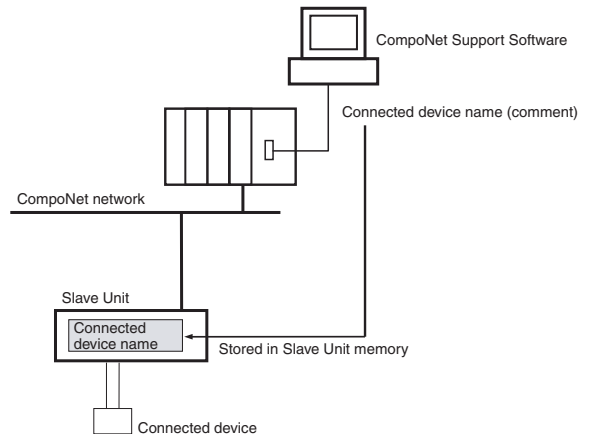

#### Communications Error History Monitor

The previous four error history records (communications error codes and the power voltage when the error occurred) can be stored in the Slave Unit memory.

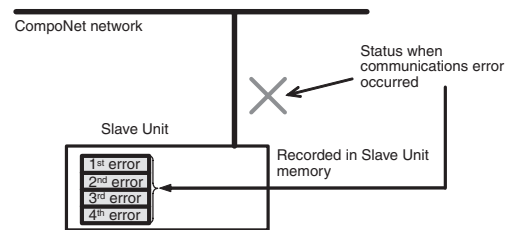

#### Last Maintenance Date

This function can be used to write the date maintenance was last performed in the Slave Unit memory. This makes it easier to decide when maintenance should be performed next.

#### Contact Operation Monitor (Digital I/O Slave, Bit Slave Input Units Only)

The number of times each input contact or output contact is turned ON can be counted (resolution: 50 Hz max.) and stored in Slave Unit memory. (This data can be read using the CompoNet Support Software or using explicit messages.)

A monitor value can also be stored in the Slave Unit memory so once the number of contact operations reaches the monitor value, a flag in a status area in the Slave Unit turns ON to notify the Master Unit. The notification details can be read using the CompoNet Support Software or using explicit messages.

- No. of times measured: 0 to 4,294,967,295 (Stored data: 0000 0000 to FFFF FFFF hex)
- Measurement unit: No. of operations

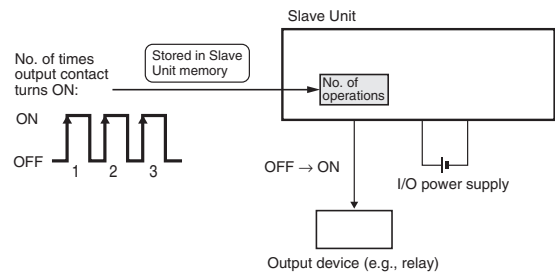

- Note 1.** The contact operation monitor and the total ON time monitor cannot both be used for the same contact at the same time. Select only one of these functions under the *Operation Monitor Mode*.
- 2.** This function does not operate if the I/O power is not turned ON.

● **Total ON Time Monitor (Digital I/O Slave, Bit Slave Input Units Only)**

This function totals the time that each input and output contact is ON (unit: s) and stores this total time in the Slave Unit memory. (This data can be read using the CompoNet Support Software or using explicit messages.)

A monitor value can also be stored in the Slave Unit memory so once the set total time has been reached, a flag in a status area in the Slave Unit turns ON to notify the Master Unit. The notification details can be read using the CompoNet Support Software or using explicit messages.

- Measurement time: 0 to 4,294,967,295 s (Stored data: 0000 0000 to FFFF FFFF Hex)
- Measurement unit: s

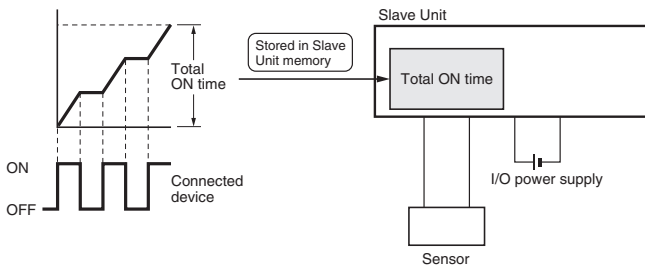

- Note 1.** The total ON time monitor and the contact operation monitor cannot both be used for the same contact at the same time. Select only one of these functions under the *Operation Monitor Mode*.
2. This function does not operate if the I/O power is not turned ON.
  3. The Total ON Time Monitor Function checks at 1 second intervals whether or not the connected device is turned ON. Keep this in mind when measuring total ON times for inputs of less than 1 s.

● **Input Filter (Digital I/O Slave, Bit Slave Input Units Only)**

Input values can be read more than once during the set time interval to eliminate data emissions due to noise and switch chattering. An ON delay or OFF delay can also be implemented using this function.

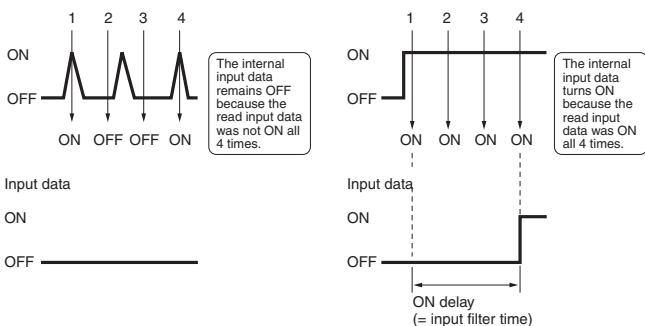

● **Preventing Malfunctions Caused by Inrush Current at Startup (Input Units Only) (Digital I/O Slave Units and Bit Slave Input Units Only)**

This function does not accept inputs from when the power is turned ON until the Unit stabilizes, i.e., inputs are not received while the I/O power is OFF and for 100 ms after the I/O power is turned ON.

This means input errors caused by inrush current when the I/O power is turned ON can be eliminated.

● **I/O Power Status Monitor (Digital I/O Slave Units Only)**

The I/O power status monitor function can be used to detect whether the I/O power is ON.

When the I/O power is turned OFF, a flag in a status area in the Slave Unit turns ON to notify the Master Unit. The notification details can be read using the CompoNet Support Software or using explicit messages.

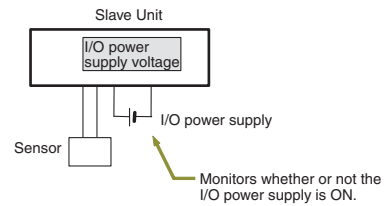

**Note:** A detection voltage cannot be set for the I/O power supply.

● **Sensor Power Short-circuit Detection (Bit Slave Units Only)**

This function monitors the sensor power supply current. If the current is 100 mA or higher per input contact, a sensor power short-circuit is detected.

The I/O power for the Slave Unit turns OFF if a short-circuit is detected for even just one of the contacts being used.

The Slave Unit SHT0 indicator can be used to check whether a sensor power short-circuit has been detected. When a sensor power short-circuit is detected, a flag in a status area in the Slave Unit turns ON to notify the Master Unit. The notification details can be read using the CompoNet Support Software or using explicit messages. When the cause of the short-circuit is removed, the Slave Unit is automatically reset, and the power output to the connector that had the short-circuit is turned ON again.

**Note:** Use a power supply rated 100 W or higher as the communications power supply.

A short-circuit is detected if a current of 100 mA or more flows two inputs in the Unit's sensor power output. The communications power supply may be temporarily cut if a short-circuit occurs. The Slave Unit is automatically restored after the cause of the short-circuit has been removed but external circuits must also be created to ensure safe system operation while the power is disconnected. Use the following formulas as a guide for calculating the sensor current consumption.

- Total network current = Total Sensor Unit current consumption + total sensor current consumption
- Communications power capacity used  $\geq$  {total network current + (short-circuit detection current = 100 mA)}  $\times$  (CompoNet network voltage)

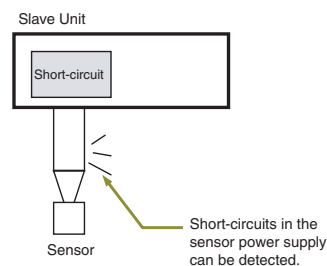

● **External Load Short-circuit Detection (Output Only) (Bit Slave Units Only)**

This function monitors the load current for the output section and detects an external load short-circuit if the current per contact (or common) exceeds a specific value. When an external load short-circuit is detected, all Unit outputs are turned OFF to prevent damage to the Unit's output circuits.

The I/O power for the Unit turns OFF if a short-circuit is detected for even just one of the contacts being used.

The Slave Unit's SHT0 or SHT1 indicators can be used to check whether an external load short-circuit has been detected. When an external load short-circuit is detected, a flag in a status area in the Slave Unit turns ON to notify the Master Unit. The notification details can be read using the CompoNet Support Software or using explicit messages.

tion details can be read using the CompoNet Support Software or using explicit messages.

When the cause of the short-circuit is removed, the Slave Unit is automatically reset, and the power output to the connector for which the short-circuit was detected is turned ON again.

**Note:** The OMRON S82J-series Power Supply Unit is recommended as the I/O power supply. Load short-circuits may not be detected for power supplies with an inverted L overcurrent protection characteristic. If using a power supply with an inverted L overcurrent protection characteristic, use one rated 100 W or higher.

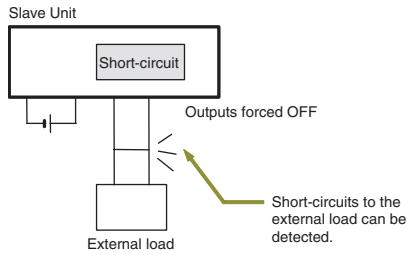

CompoNet Digital I/O Slave Units with Screw Terminal Blocks (2-tier Terminal Block/Relay Output/SSR Output)

# CRT1-ID16(-1)/OD16(-1)/ROS16/ROF16

## Visualize the actual worksite status! Simple and Intelligent I/O Slave Units.

In addition to the Digital I/O Slave Unit's basic digital ON/OFF signals, collect useful information from the Slave Unit to improve equipment operating rates and maintainability.

- Communications connector and removable I/O terminal block enable faster startup times and improved maintainability.
- One Expansion Unit can be added to each Digital I/O Slave Unit to increase system configuration flexibility.
- Collect various preventive maintenance data required to improve productivity, such as information on equipment deterioration due to aging and equipment operating time data.
- Simplify startup with the communications power supply monitoring function.



**NEW**

### Ordering Information

Name	Specifications			Communications Cables			Model	Standards
				VCTF 2-conductor cable	Standard Flat Cable I	Sheathed Flat Cable II		
Two-tier Screw Terminal Block	Inputs	16 inputs	NPN	Yes	Yes	Yes	CRT1-ID16	CE (certified), UC1 (pending)
			PNP				CRT1-ID16-1	
	Outputs	16 outputs	NPN				CRT1-OD16	
			PNP				CRT1-OD16-1	
Screw Terminal Block with Relay Outputs	Outputs	16 outputs	Contacts	Yes	Yes	Yes	CRT1-ROS16 <b>NEW</b>	CE (certified), UC1 (pending)
Screw Terminal Block with SSR Outputs	Outputs	16 outputs	SSR	Yes	Yes	Yes	CRT1-ROF16 <b>NEW</b>	---

#### International Standards

- The standards indicated in the "Standards" column are those current for UL, CSA, cULus, NK, and Lloyd standards and EC Directives as of the end of October 2007. The standards are abbreviated as follows; U: UL, U1: UL Class I Division 2 Products for Hazardous Locations, C: CSA, UC: cULus, UC1: cULus Class I Division 2 Products for Hazardous Locations, CU: cUL, N: NK, L: Lloyd, and CE: EC Directive.
- Ask your OMRON representative for the conditions under which the standards were met.

#### Expansion Units

One Expansion Unit can be combined with one Digital I/O Slave Unit (CRT1-ID16(-1), CRT1-OD16(-1), CRT1-ROS16, or CRT1-ROF16). The following Expansion Units are available. They can be combined in various ways for flexible I/O capacity expansion.

Model	I/O points	Input capacity	Output capacity
XWT-ID08	8 DC inputs (NPN)	8	0
XWT-ID08-1	8 DC inputs (PNP)	8	0
XWT-OD08	8 transistor outputs (NPN)	0	8
XWT-OD08-1	8 transistor outputs (PNP)	0	8
XWT-ID16	16 DC inputs (NPN)	16	0
XWT-ID16-1	16 DC inputs (PNP)	16	0
XWT-OD16	16 transistor outputs (NPN)	0	16
XWT-OD16-1	16 transistor outputs (PNP)	0	16

## Performance Specifications

### ● 2-tier Terminal Block

Item	Specification
Communications power supply voltage	14 to 26.4 VDC
I/O power supply voltage	20.4 to 26.4 VDC (24 VDC -15%/+10%)
Noise immunity	Conforms to IEC 61000-4-4 2 kV (power line).
Vibration resistance	10 to 60 Hz with double-amplitude of 0.7 mm, 60 to 150 Hz and 50 m/s <sup>2</sup> in X, Y, and Z directions for 80 min each
Shock resistance	150 m/s <sup>2</sup> (3 times each in 6 directions on 3 axes)
Dielectric strength	500 VAC (between isolated circuits)
Insulation resistance	20 MΩ min. (between isolated circuits)
Ambient operating temperature	-10 to 55°C
Ambient operating humidity	25% to 85% (with no condensation)
Ambient operating atmosphere	No corrosive gases
Storage temperature	-25 to 65°C
Storage humidity	25% to 85% (with no condensation)
Tightening torque for the terminal block screws	M3 terminal screws: 0.5 N·m M3 mounting screws: 0.5 N·m
Installation	Mounted on 35-mm DIN Track

### ● Relay Output/SSR Output

Item	Specification
Communications power supply voltage	14 to 26.4 VDC
I/O power supply voltage	20.4 to 26.4 VDC (24 VDC -15%/+10%)
Noise immunity	Conforms to IEC 61000-4-4 2 kV (power line).
Vibration resistance	10 to 60 Hz with double-amplitude of 0.7 mm, 60 to 150 Hz and 50 m/s <sup>2</sup> in X, Y, and Z directions for 80 min each
Shock resistance	150 m/s <sup>2</sup> (3 times in 6 directions on 3 axes)
Dielectric strength	500 VAC (between isolated circuits)
Insulation resistance	20 MΩ min. (between isolated circuits)
Ambient operating temperature	-10 to 55°C
Ambient operating humidity	25% to 85% (with no condensation)
Ambient operating atmosphere	No corrosive gases
Storage temperature	-25 to 65°C
Storage humidity	25% to 85% (with no condensation)
Tightening torque for the terminal block screws	M3 terminal screws: 0.5 N·m M3 mounting screws: 0.5 N·m
Installation	Mounted on 35-mm DIN Track

## Input Section Specifications

### ● Sixteen-point Input Units (2-tier Terminal Block)

Item	Specification	
Model	CRT1-ID16	CRT1-ID16-1
I/O capacity	16 inputs	
Internal I/O common	NPN	PNP
ON voltage	15 VDC min. (between each input terminal and the V terminal)	15 VDC min. (between each input terminal and the G terminal)
OFF voltage	5 VDC max. (between each input terminal and the V terminal)	5 VDC max. (between each input terminal and the G terminal)
OFF current	1 mA max.	
Input current	At 24 VDC: 6.0 mA max./input At 17 VDC: 3.0 mA max./input	
ON delay	1.5 ms max.	
OFF delay	1.5 ms max.	
Number of circuits per common	16 inputs/common	
Isolation method	Photocoupler	
Input indicator	LED (yellow)	
Installation	DIN Track mounting	
Power supply type	Multi-power supply (Communications power and I/O power must be supplied separately.)	
Communications power supply current consumption	55 mA max. for 24-VDC power supply voltage 85 mA max. for 14-VDC power supply voltage	
Weight	141 g max.	

## Output Section Specifications

### ● Sixteen-point Output Units (2-tier Terminal Block)

Item	Specification	
Model	CRT1-OD16	CRT1-OD16-1
I/O capacity	16 outputs	
Internal I/O common	NPN	PNP
Rated output current	0.5 A/output, 4 A/common	
Residual voltage	1.2 V max. (0.5 A DC, between each output terminal and the G terminal)	1.2 V max. (0.5 A DC, between each output terminal and the V terminal)
Leakage current	0.1 mA max.	
ON delay	0.5 ms max.	
OFF delay	1.5 ms max.	
Number of circuits per common	16 outputs/common	
Isolation method	Photocoupler	
Output indicators	LED (yellow)	
Installation	DIN Track mounting	
Power supply type	Multi-power supply (Communications power and I/O power must be supplied separately.)	
Communications power supply current consumption	55 mA max. for 24-VDC power supply voltage 85 mA max. for 14-VDC power supply voltage	
Output handling for communications errors	Hold or clear can be selected. (CompoNet Support Software)	
Weight	141 g max.	

### ● Sixteen-point Output Units (Relay Outputs) (per Output)

Item	Specification
Model	CRT1-ROS16
I/O capacity	16 outputs
Mounted Relays	DRTA-NY5W-K (5 VDC)
Rated load	Resistive load 250 VAC, 2 A, common: 8 A 30 VDC, 2 A, common: 8 A
Rated ON current	3 A
Maximum contact voltage	250 VAC, 125 VDC
Maximum contact current	3 A
Maximum switching capacity	750 VA AC, 90 W DC
Minimum applicable load (reference value)	5 VDC, 1 mA
Mechanical service life	20,000,000 operations min.
Electrical service life	100,000 operations min.
Installation	DIN Track mounting
Communications power supply current consumption	155 mA max. for 24-VDC power supply voltage 255 mA max. for 14-VDC power supply voltage
Output hold for communications errors	Hold or clear can be selected. (CompoNet Support Software)
Weight	260 g max.

### ● Sixteen-point Output Units (SSR Outputs) (per Output)

Item	Specification
Model	CRT1-ROF16
I/O capacity	16 outputs
Load voltage	24 to 265 VAC
Load current	0.3 A
Inrush current resistivity	50 A (60 Hz)
Installation	DIN Track mounting
Communications power supply current consumption	85 mA max. for 24-VDC power supply voltage 130 mA max. for 14-VDC power supply voltage
Output hold for communications errors	Hold or clear can be selected. (CompoNet Support Software)
Weight	250 g max.

Note: The SSRs cannot be replaced.

### Load Current vs. Ambient Temperature

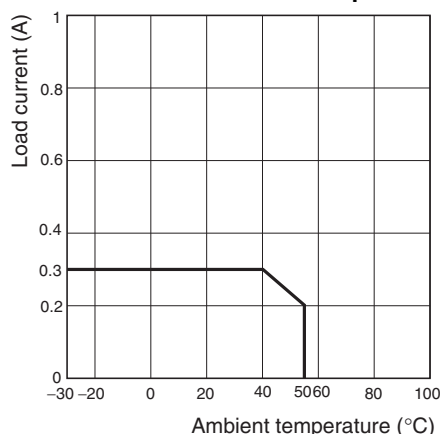

**CompoNet Digital I/O Slave Units with Screw Terminal Blocks (3-tier Terminal Block)**  
**CRT1-ID16TA(-1)/OD16TA(-1)/MD16TA(-1)**

**With the relay terminal blocks, doubling up wires on terminals is not necessary! Smart Slave Units with Easy-to-understand Wiring Locations with One Common for Every Point.**

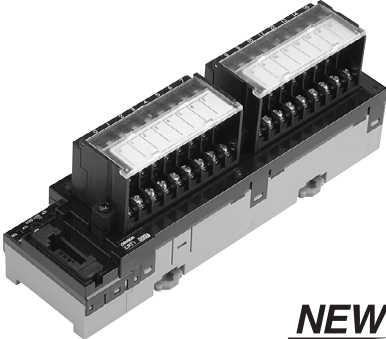

**NEW**

**Doubling up wires on terminals is unnecessary and wiring locations are easy to understand with these Smart Slaves with 3-tier Terminal Blocks.**

- Easy-to-understand wiring. No doubling up of wires. Easy-to-understand wiring locations.
- Simplify startup with the communications power supply monitor (Smart function).
- Collect various preventive maintenance data required to improve productivity, such as information on equipment deterioration due to aging and equipment operating time data (Smart function).
- The communications baud rate is set without using switches and addresses are set using rotary switches, so setting errors are reduced.
- Communications connector and removable I/O terminal block enable maintenance without disconnecting wiring.

**Ordering Information**

Name	Specifications			Communications Cables			Model	Standards
				VCTF 2-conductor cable	Standard Flat Cable I	Sheathed Flat Cable II		
Three-tier Screw Terminal Block	Inputs	16 inputs	NPN	Yes	Yes	Yes	CRT1-ID16TA	CE (certified), UC1 (pending)
			PNP				CRT1-ID16TA-1	
	Outputs	16 outputs	NPN				CRT1-OD16TA	
			PNP				CRT1-OD16TA-1	
	Inputs/outputs	8 inputs and 8 outputs	NPN				CRT1-MD16TA	
			PNP				CRT1-MD16TA-1	

**International Standards**

- The standards indicated in the “Standards” column are those current for UL, CSA, cULus, NK, and Lloyd standards and EC Directives as of the end of October 2007. The standards are abbreviated as follows; U: UL, U1: UL Class I Division 2 Products for Hazardous Locations, C: CSA, UC: cULus, UC1: cULus Class I Division 2 Products for Hazardous Locations, CU: cUL, N: NK, L: Lloyd, and CE: EC Directive.
- Ask your OMRON representative for the conditions under which the standards were met.

## Performance Specifications

Item	Specification
Communications power supply voltage	14 to 26.4 VDC
I/O power supply voltage	20.4 to 26.4 VDC (24 VDC -15%/+10%)
Noise immunity	Conforms to IEC 61000-4-4 2 kV (power line).
Vibration resistance	10 to 60 Hz with double-amplitude of 0.7 mm, 60 to 150 Hz and 50 m/s <sup>2</sup> in X, Y, and Z directions for 80 min each
Shock resistance	150 m/s <sup>2</sup> (3 times each in 6 directions on 3 axes)
Dielectric strength	500 VAC (between isolated circuits)
Insulation resistance	20 MΩ min. (between isolated circuits)
Ambient operating temperature	-10 to 55°C
Ambient operating humidity	25% to 85% (with no condensation)
Ambient operating atmosphere	No corrosive gases
Storage temperature	-25 to 65°C
Storage humidity	25% to 85% (with no condensation)
Tightening torque for the terminal block screws	M3 terminal screws: 0.5 N·m M3 mounting screws: 0.5 N·m
Installation	Mounted on 35-mm DIN Track

## Input Section Specifications

### ● Sixteen-point Input Units (3-tier Terminal Block)

Item	Specification	
Model	CRT1-ID16TA	CRT1-ID16TA-1
I/O capacity	16 inputs	
Internal I/O common	NPN	PNP
ON voltage	15 VDC min. (between each input terminal and the V terminal)	15 VDC min. (between each input terminal and the G terminal)
OFF voltage	5 VDC max. (between each input terminal and the V terminal)	5 VDC max. (between each input terminal and the G terminal)
OFF current	1.0 mA max.	
Input current	At 24 VDC: 6.0 mA max./input At 17 VDC: 3.0 mA max./input	
ON delay	1.5 ms max.	
OFF delay	1.5 ms max.	
Number of circuits per common	8 inputs/common	
Isolation method	Photocoupler	
Input indicator	LED (yellow)	
Installation	DIN Track mounting	
Power supply type	Multi-power supply	
Communications power supply current consumption	40 mA max. for 24-VDC power supply voltage 55 mA max. for 14-VDC power supply voltage	37 mA max. for 24-VDC power supply voltage 55 mA max. for 14-VDC power supply voltage
I/O power supply current consumption	3.6 mA max. for 24-VDC power supply voltage	3.5 mA max. for 24-VDC power supply voltage
Weight	330 g max.	



## Output Section Specifications

### ● Sixteen-point Output Unit (3-tier Terminal Block)

Item	Specification	
Model	CRT1-OD16TA	CRT1-OD16TA-1
I/O capacity	16 outputs	
Internal I/O common	NPN	PNP
Rated output current	0.5 A/output, 2 A/common	
Residual voltage	1.2 V max. (0.5 A DC, between each output terminal and the G terminal)	1.2 V max. (0.5 A DC, between each output terminal and the V terminal)
Leakage current	0.1 mA max.	
ON delay	0.5 ms max.	
OFF delay	1.5 ms max.	
Number of circuits per common	8 outputs/common	
Isolation method	Photocoupler	
Output indicators	LED (yellow)	
Installation	DIN Track mounting	
Power supply type	Multi-power supply	
Communications power supply current consumption	45 mA max. for 24-VDC power supply voltage 65 mA max. for 14-VDC power supply voltage	
I/O power supply current consumption	12 mA max. for 24-VDC power supply voltage	
Output handling for communications errors	Hold or clear can be selected. (CompoNet Support Software)	
Weight	330 g max.	

## Input and Output Section Specifications

### ● 8-point Input and 8-point Output Units (3-tier Terminal Block)

#### Basic Specifications

Item	Specification
Installation	DIN Track mounting
Communications power supply current consumption	40 mA max. for 24-VDC power supply voltage 60 mA max. for 14-VDC power supply voltage
Weight	330 g max.

#### Input Section Specifications

Item	Specification	
Model	CRT1-MD16TA	CRT1-MD16TA-1
I/O capacity	8 inputs	
Internal I/O common	NPN	PNP
ON voltage	15 VDC min. (between each input terminal and the V terminal)	15 VDC min. (between each input terminal and the G terminal)
OFF voltage	5 VDC max. (between each input terminal and the V terminal)	5 VDC max. (between each input terminal and the G terminal)
OFF current	1.0 mA max.	
Input current	At 24 VDC: 6.0 mA max./input At 17 VDC: 3.0 mA max./input	
ON delay	1.5 ms max.	
OFF delay	1.5 ms max.	
Number of circuits per common	8 inputs/common	
Isolation method	Photocoupler	
Input indicator	LED (yellow)	
Power supply type	Multi-power supply	
I/O power supply current consumption	3.5 mA max. for 24-VDC power supply voltage	

#### Output Section Specifications

Item	Specification	
Model	CRT1-MD16TA	CRT1-MD16TA-1
I/O capacity	8 outputs	
Internal I/O common	NPN	PNP
Rated output current	0.5 A/output, 2 A/common	
Residual voltage	1.2 V max. (0.5 A DC, between each output terminal and the G terminal)	1.2 V max. (0.5 A DC, between each output terminal and the V terminal)
Leakage current	0.1 mA max.	
ON delay	0.5 ms max.	
OFF delay	1.5 ms max.	
Number of circuits per common	8 outputs/common	
Isolation method	Photocoupler	
Output indicators	LED (yellow)	
I/O power supply current consumption	12 mA max. for 24-VDC power supply voltage	
Output handling for communications errors	Hold or clear can be selected. (CompoNet Support Software)	

CompoNet Digital I/O Slave Units with Connectors

# CRT1-ID16S(-1)/OD16S(-1)/MD16S(-1)

## Industry-standard Sensor Connectors for Easy Connection to Pre-wired Sensors without Special Tools.

- A digital I/O terminal with industry-standard sensor connectors.
- Easy to install without the use of special tools. Reduces wiring work.
- Equipped with load short-circuit detection.

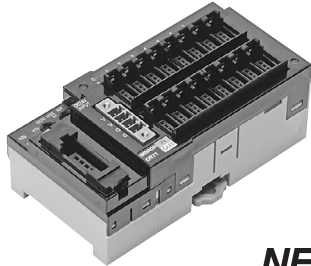

**NEW**

### Ordering Information

Name	Specifications			Communications Cables			Model	Standards	
				VCTF 2-conductor cable	Standard Flat Cable I	Sheathed Flat Cable II			
Digital I/O Slave Units with Connectors	Inputs	16 inputs	NPN	Yes	Yes	Yes	CRT1-ID16S	<b><u>NEW</u></b>	CE (certified), UC1 (pending)
			PNP				CRT1-ID16S-1	<b><u>NEW</u></b>	
	Outputs	16 outputs	NPN				CRT1-OD16S	<b><u>NEW</u></b>	
			PNP				CRT1-OD16S-1	<b><u>NEW</u></b>	
	Inputs/outputs	8 inputs and 8 outputs	NPN				CRT1-MD16S	<b><u>NEW</u></b>	
			PNP				CRT1-MD16S-1	<b><u>NEW</u></b>	

### International Standards

- The standards indicated in the “Standards” column are those current for UL, CSA, cULus, NK, and Lloyd standards and EC Directives as of the end of October 2007. The standards are abbreviated as follows; U: UL, U1: UL Class I Division 2 Products for Hazardous Locations, C: CSA, UC: cULus, UC1: cULus Class I Division 2 Products for Hazardous Locations, CU: cUL, N: NK, L: Lloyd, and CE: EC Directive.
- Ask your OMRON representative for the conditions under which the standards were met.

### Performance Specifications

Item	Specification
Communications power supply voltage	14 to 26.4 VDC
I/O power supply voltage	20.4 to 26.4 VDC (24 VDC -15%/+10%)
Noise immunity	Conforms to IEC 61000-4-4 2 kV (power line).
Vibration resistance	10 to 60 Hz with double-amplitude of 0.7 mm, 60 to 150 Hz and 50 m/s <sup>2</sup> in X, Y, and Z directions for 80 min each
Shock resistance	150 m/s <sup>2</sup> (3 times each in 6 directions on 3 axes)
Dielectric strength	500 VAC (between isolated circuits)
Insulation resistance	20 MΩ min. (between isolated circuits)
Ambient operating temperature	-10 to 55°C
Ambient operating humidity	25% to 85% (with no condensation)
Ambient operating atmosphere	No corrosive gases
Storage temperature	-25 to 65°C
Storage humidity	25% to 85% (with no condensation)
Installation	Mounted on 35-mm DIN Track

## Input Section Specifications

### ● Sixteen-point Input Units

Item	Specification	
Model	CRT1-ID16S	CRT1-ID16S-1
I/O capacity	16 inputs	
Internal I/O common	NPN	PNP
ON voltage	10.5 VDC min. (between each input terminal and the V terminal)	10.5 VDC min. (between each input terminal and the G terminal)
OFF current	1.0 mA max.	
Input current	At 24 VDC: 6.0 mA max./input At 11 VDC: 3.0 mA max./input	
ON delay	1.5 ms max.	
OFF delay	1.5 ms max.	
Number of circuits per common	16 inputs/common	
Isolation method	Photocoupler	
Input indicator	LED (yellow)	
Installation	DIN Track mounting	
Power supply type	Network power supply	
Communications power supply current consumption	110 mA max. for 24-VDC power supply voltage 125 mA max. for 14-VDC power supply voltage	110 mA max. for 24-VDC power supply voltage 120 mA max. for 14-VDC power supply voltage
Weight	110 g max.	

## Output Section Specifications

### ● Sixteen-point Output Unit

Item	Specification	
Model	CRT1-OD16S	CRT1-OD16S-1
I/O capacity	16 outputs	
Internal I/O common	NPN	PNP
Rated output current	0.5 A/output, 4 A/common	
Residual voltage	1.2 V max. (0.5 A DC, between each output terminal and the G terminal)	1.2 V max. (0.5 A DC, between each output terminal and the V terminal)
Leakage current	0.1 mA max.	
ON delay	0.5 ms max.	
OFF delay	1.5 ms max.	
Number of circuits per common	16 outputs/common	
Isolation method	Photocoupler	
Output indicators	LED (yellow)	
Installation	DIN Track mounting	
Power supply type	Multi-power supply	
Communications power supply current consumption	38 mA max. for 24-VDC power supply voltage 60 mA max. for 14-VDC power supply voltage	39 mA max. for 24-VDC power supply voltage 60 mA max. for 14-VDC power supply voltage
I/O power supply current consumption	20 mA max. for 24-VDC power supply voltage	
Output handling for communications errors	Hold or clear can be selected. (CompoNet Support Software)	
Weight	110 g max.	

## Input and Output Section Specifications

### ● 8-point Input and 8-point Output Units

#### Basic Specifications

Item	Specification
Installation	DIN Track mounting
Communications power supply current consumption	75 mA max. for 24-VDC power supply voltage 95 mA max. for 14-VDC power supply voltage
Weight	120 g max.

#### Input Section Specifications

Item	Specification	
Model	CRT1-MD16S	CRT1-MD16S-1
I/O capacity	8 inputs	
Internal I/O common	NPN	PNP
ON voltage	10.5 VDC min. (between each input terminal and the V terminal)	10.5 VDC min. (between each input terminal and the G terminal)
OFF current	1.0 mA max.	
Input current	At 24 VDC: 6.0 mA max./input At 11 VDC: 3.0 mA max./input	
ON delay	1.5 ms max.	
OFF delay	1.5 ms max.	
Number of circuits per common	8 inputs/common	
Isolation method	Photocoupler	
Input indicator	LED (yellow)	
Power supply type	Network power supply	

#### Output Section Specifications

Item	Specification	
Model	CRT1-MD16S	CRT1-MD16S-1
I/O capacity	8 outputs	
Internal I/O common	NPN	PNP
Rated output current	0.5 A/output, 2 A/common	
Residual voltage	1.2 V max. (0.5 A DC, between each output terminal and the G terminal)	1.2 V max. (0.5 A DC, between each output terminal and the V terminal)
Leakage current	0.1 mA max.	
ON delay	0.5 ms max.	
OFF delay	1.5 ms max.	
Number of circuits per common	8 outputs/common	
Isolation method	Photocoupler	
Output indicators	LED (yellow)	
Power supply type	Multi-power supply	
I/O power supply current consumption	12 mA max. for 24-VDC power supply voltage	
Output handling for communications errors	Hold or clear can be selected. (CompoNet Support Software)	

CompoNet Digital I/O Slaves with Clamp Terminals

# CRT1-ID16SL(-1)/OD16SL(-1)

## Screw-less Terminal Wiring Further Reduces Wiring Work and Saves Labor at the Production Site.

- Screw-less (M3) design eliminates the need for extra tightening.
- Removable terminal block gives powerful support to maintenance work.
- One-step wiring. Wire simply by inserting the ferrules.
- Applicable wire: AWG24 to AWG16 (cross-section: 0.2 to 1.25 mm<sup>2</sup>)

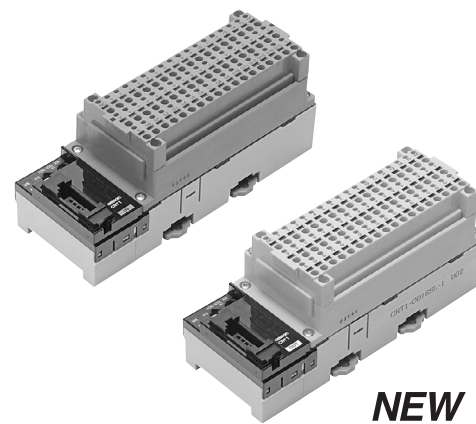

### Ordering Information

Name	Specifications			Communications Cables			Model	Standards
				VCTF 2-conductor cable	Standard Flat Cable I	Sheathed Flat Cable II		
Digital I/O Slaves with Clamp Terminals	Inputs	16 inputs	NPN	Yes	Yes	Yes	CRT1-ID16SL	CE (certified), UC1 (pending)
			PNP				CRT1-ID16SL-1	
	Outputs	16 outputs	NPN				CRT1-OD16SL	
			PNP				CRT1-OD16SL-1	

### International Standards

- The standards indicated in the “Standards” column are those current for UL, CSA, cULus, NK, and Lloyd standards and EC Directives as of the end of October 2007. The standards are abbreviated as follows; U: UL, U1: UL Class I Division 2 Products for Hazardous Locations, C: CSA, UC: cULus, UC1: cULus Class I Division 2 Products for Hazardous Locations, CU: cUL, N: NK, L: Lloyd, and CE: EC Directive.
- Ask your OMRON representative for the conditions under which the standards were met.

### Performance Specifications

Item	Specification
Communications power supply voltage	14 to 26.4 VDC
I/O power supply voltage	20.4 to 26.4 VDC (24 VDC -15%/+10%)
Noise immunity	Conforms to IEC 61000-4-4 2 kV (power line).
Vibration resistance	10 to 60 Hz with double-amplitude of 0.7 mm, 60 to 150 Hz and 50 m/s <sup>2</sup> in X, Y, and Z directions for 80 min each
Shock resistance	150 m/s <sup>2</sup> (3 times each in 6 directions on 3 axes)
Dielectric strength	500 VAC (between isolated circuits)
Insulation resistance	20 MΩ min. (between isolated circuits)
Ambient operating temperature	-10 to 55°C
Ambient operating humidity	25% to 85% (with no condensation)
Ambient operating atmosphere	No corrosive gases
Storage temperature	-25 to 65°C
Storage humidity	25% to 85% (with no condensation)
Installation	Mounted on 35-mm DIN Track

## Input Section Specifications

### ● Sixteen-point Input Units

Item	Specification	
Model	CRT1-ID16SL	CRT1-ID16SL-1
I/O capacity	16 inputs	
Internal I/O common	NPN	PNP
ON voltage	15 VDC min. (between each input terminal and the V terminal)	15 VDC min. (between each input terminal and the G terminal)
OFF voltage	5 VDC max. (between each input terminal and the V terminal)	5 VDC max. (between each input terminal and the G terminal)
OFF current	1.0 mA max.	
Input current	At 24 VDC: 6.0 mA max./input At 17 VDC: 3.0 mA max./input	
ON delay	1.5 ms max.	
OFF delay	1.5 ms max.	
Number of circuits per common	16 inputs/common	
Isolation method	Photocoupler	
Input indicator	LED (yellow)	
Installation	DIN Track mounting	
Power supply type	Multi-power supply	
Communications power supply current consumption	34 mA max. for 24-VDC power supply voltage 55 mA max. for 14-VDC power supply voltage	
I/O power supply current consumption	13 mA max. for 24-VDC power supply voltage	
Weight	250 g max.	

## Output Section Specifications

### ● Sixteen-point Output Unit

Item	Specification	
Model	CRT1-OD16SL	CRT1-OD16SL-1
I/O capacity	16 outputs	
Internal I/O common	NPN	PNP
Rated output current	0.5 A/output, 4 A/common	
Residual voltage	1.2 V max. (0.5 A DC, between each output terminal and the G terminal)	1.2 V max. (0.5 A DC, between each output terminal and the V terminal)
Leakage current	0.1 mA max.	
ON delay	0.5 ms max.	
OFF delay	1.5 ms max.	
Number of circuits per common	16 outputs/common	
Isolation method	Photocoupler	
Output indicators	LED (yellow)	
Installation	DIN Track mounting	
Power supply type	Multi-power supply	
Communications power supply current consumption	37 mA max. for 24-VDC power supply voltage 60 mA max. for 14-VDC power supply voltage	
I/O power supply current consumption	29 mA max. for 24-VDC power supply voltage	30 mA max. for 24-VDC power supply voltage
Output handling for communications errors	Hold or clear can be selected. (CompoNet Support Software)	
Weight	250 g max.	

CompoNet Analog I/O Slave Units

# CRT1-AD04/DA02

## Convert to Smart for Smarter Processing! Simple and Intelligent Analog I/O Slaves

In addition to analog data input and output, Analog I/O Slave Units can use a variety of functions internally, such as scaling, that previously required processing in ladder programming at the host PLC.

- Analog processing equivalent to digital panel meters is supported, such as with the scaling function.
- Use deviation and cumulative counter functions for analog calculations, such as for equipment error prediction and flowrate applications.
- The user adjustment function can be used to compensate offsets in inputs or outputs.
- Easily change the input or output range with a switch setting.

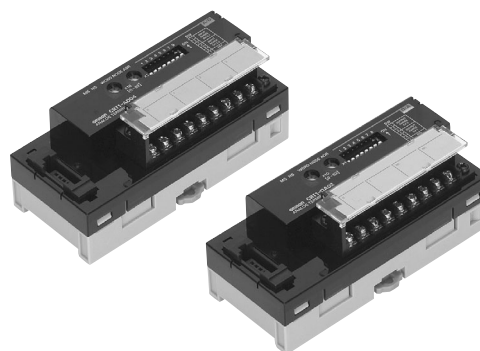

### Ordering Information

Name	Specifications		Communications Cables			Model	Standards
			VCTF 2-conductor cable	Standard Flat Cable I	Sheathed Flat Cable II		
Analog I/O Slave Units	Analog inputs	4 inputs	Yes	Yes	Yes	CRT1-AD04	CE, UC1 (pending)
	Analog outputs	2 outputs				CRT1-DA02	

### International Standards

- The standards indicated in the “Standards” column are those current for UL, CSA, cULus, NK, and Lloyd standards and EC Directives as of the end of October 2007. The standards are abbreviated as follows; U: UL, U1: UL Class I Division 2 Products for Hazardous Locations, C: CSA, UC: cULus, UC1: cULus Class I Division 2 Products for Hazardous Locations, CU: cUL, N: NK, L: Lloyd, and CE: EC Directive.
- Ask your OMRON representative for the conditions under which the standards were met.

### Performance Specifications

Item	Specification
Communications power supply voltage	14 to 26.4 VDC
I/O power supply voltage	20.4 to 26.4 VDC (24 VDC -15%/+10%)
Noise immunity	Conforms to IEC 61000-4-4 2 kV (power line).
Vibration resistance	10 to 60 Hz with double-amplitude of 0.7 mm, 60 to 150 Hz and 50 m/s <sup>2</sup> in X, Y, and Z directions for 80 min each
Shock resistance	150 m/s <sup>2</sup> (3 times each in 6 directions on 3 axes)
Dielectric strength	500 VAC (between isolated circuits)
Insulation resistance	20 MΩ min. (between isolated circuits)
Ambient operating temperature	-10 to 55°C
Ambient operating humidity	25% to 85% (with no condensation)
Ambient operating atmosphere	No corrosive gases
Storage temperature	-25 to 65°C
Storage humidity	25% to 85% (with no condensation)
Tightening torque for the terminal block screws	M3 terminal screws: 0.5 N·m M3 mounting screws: 0.5 N·m
Installation	Mounted on 35-mm DIN Track



## Input Section Specifications

Item	Specification	
	Voltage input	Current input
Model	CRT1-AD04	
Input signal ranges	0 to 5 V 1 to 5 V 0 to 10 V -10 to 10 V	0 to 20 mA 4 to 20 mA
Maximum signal input	±15 V	±30 mA
Input impedance	1 M Ω min.	Approx. 250 Ω
Resolution	1/6,000 (full scale)	
Overall accuracy	25°C	±0.3% FS ±0.4% FS (See note.)
	-10 to 55°C	±0.6% FS ±0.8% FS (See note.)
Analog conversion cycle	4 ms max./4 points	
AD conversion data	-10 to 10 V range: F448 to 0BB8 hex full scale (-3,000 to 3,000) Other ranges: 0000 to 1770 hex full scale (0 to 6,000) AD conversion range: ±5% FS of the above data ranges.	
Isolation method	Photocoupler isolation (between input and communications lines) No isolation between input signal wires	
Installation	DIN Track mounting	
Power supply type	Multi-power supply	
Communications power current consumption	110 mA max. for 24-VDC power supply 175 mA max. for 14-VDC power supply	
Weight	153 g	

**Note:** The specified accuracy does not apply below 0.2 mA when using the 0 to 20 mA range.

## Output Section Specifications

Item	Specification	
	Voltage output	Current output
Model	CRT1-DA02	
Output signal ranges	0 to 5 V 1 to 5 V 0 to 10 V -10 to 10 V	0 to 20 mA 4 to 20 mA
External output allowable load resistance	1 kΩ min.	600 Ω max.
Resolution	1/6,000 (full scale)	
Overall accuracy	25°C	±0.4% FS ±0.4% FS (See note.)
	-10 to 55°C	±0.8% FS ±0.8% FS (See note.)
Conversion time	2 ms max./2 points	
DA conversion data	-10 to 10 V range: F448 to 0BB8 hex full scale (-3,000 to 3,000) Other ranges: 0000 to 1770 hex full scale (0 to 6,000) AD conversion range: ±5% FS of the above data ranges.	
Isolation method	Photocoupler isolation (between output and communications lines) No isolation between output signal wires.	
Installation	DIN Track mounting	
Power supply type	Multi-power supply	
Communications power current consumption	125 mA max. for 24-VDC power supply 205 mA max. for 14-VDC power supply	
Weight	155 g	

**Note:** The specified accuracy does not apply below 0.2 mA when using the 0 to 20 mA range.

## Expansion Units

# XWT-ID08(-1)/OD08(-1)/ID16(-1)/OD16(-1)

## Expansion I/O Units make expansion easy!

One Expansion Unit can be added to each Digital I/O Slave Unit. This makes a variety of I/O combinations possible, such as 16 inputs + 8 outputs, extending the range of possible system configurations.

- Flexible expansion with many different combinations.
- Removable I/O terminal block enables faster startup time and improved maintainability.
- Collect various preventive maintenance data required to improve productivity, such as information on equipment deterioration due to aging and equipment operating time data.

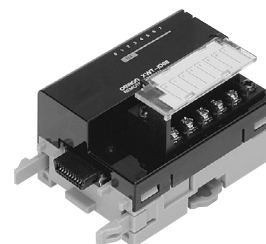

## Ordering Information

Name		Specifications			Model	Standards
Expansion Units	Inputs	8 inputs	NPN	One Expansion Unit can be mounted to each Digital I/O Slave with a 2-tier Screw Terminal Block.	XWT-ID08	CE, UC1, N
			PNP		XWT-ID08-1	
	Outputs	8 outputs	NPN		XWT-OD08	
			PNP		XWT-OD08-1	
	Inputs	16 inputs	NPN		XWT-ID16	
			PNP		XWT-ID16-1	
	Outputs	16 outputs	NPN		XWT-OD16	
			PNP		XWT-OD16-1	

## International Standards

- The standards indicated in the “Standards” column are those current for UL, CSA, cULus, NK, and Lloyd standards and EC Directives as of the end of October 2007. The standards are abbreviated as follows; U: UL, U1: UL Class I Division 2 Products for Hazardous Locations, C: CSA, UC: cULus, UC1: cULus Class I Division 2 Products for Hazardous Locations, CU: cUL, N: NK, L: Lloyd, and CE: EC Directive.
- Ask your OMRON representative for the conditions under which the standards were met.

## Performance Specifications

Item	Specification
Communications power supply voltage	14 to 26.4 VDC
I/O power supply voltage	20.4 to 26.4 VDC (24 VDC -15%/+10%)
Noise immunity	Conforms to IEC 61000-4-4 2 kV (power line).
Vibration resistance	10 to 60 Hz with double-amplitude of 0.7 mm, 60 to 150 Hz and 50 m/s <sup>2</sup> in X, Y, and Z directions for 80 min each
Shock resistance	150 m/s <sup>2</sup> (3 times each in 6 directions on 3 axes)
Dielectric strength	500 VAC (between isolated circuits)
Insulation resistance	20 MΩ min. (between isolated circuits)
Ambient operating temperature	-10 to 55°C
Ambient operating humidity	25% to 85% (with no condensation)
Ambient operating atmosphere	No corrosive gases
Storage temperature	-25 to 65°C
Storage humidity	25% to 85% (with no condensation)
Tightening torque for the terminal block screws	M3 terminal screws: 0.5 N·m M3 mounting screws: 0.5 N·m
Installation	Mounted on 35-mm DIN Track

## Input Section Specifications

Item	Specification			
Model	XWT-ID08	XWT-ID08-1	XWT-ID16	XWT-ID16-1
Internal I/O common	NPN	PNP	NPN	PNP
I/O capacity	8 inputs		16 inputs	
ON voltage	15 VDC min. (between each input terminal and the V terminal)	15 VDC min. (between each input terminal and the G terminal)	15 VDC min. (between each input terminal and the V terminal)	15 VDC min. (between each input terminal and the G terminal)
OFF voltage	5 VDC max. (between each input terminal and the V terminal)	5 VDC max. (between each input terminal and the G terminal)	5 VDC max. (between each input terminal and the V terminal)	5 VDC max. (between each input terminal and the G terminal)
OFF current	1.0 mA max.			
Input current	At 24 VDC: 6.0 mA max./input At 17 VDC: 3.0 mA max./input			
ON delay	1.5 ms max.			
OFF delay	1.5 ms max.			
Number of circuits per common	8 inputs/common		16 inputs/common	
Communications power supply current consumption	5 mA		10 mA	
Weight	80 g max.		120 g max.	

## Output Section Specifications

Item	Specification			
Model	XWT-OD08	XWT-OD08-1	XWT-OD16	XWT-OD16-1
Internal I/O common	NPN	PNP	NPN	PNP
I/O capacity	8 outputs		16 outputs	
Rated output current	0.5 A/output, 2.0 A/common		0.5 A/output, 4.0 A/common	
Residual voltage	1.2 V max. (0.5 A DC, between each output terminal and the G terminal)	1.2 V max. (0.5 A DC, between each output terminal and the V terminal)	1.2 V max. (0.5 A DC, between each output terminal and the G terminal)	1.2 V max. (0.5 A DC, between each output terminal and the V terminal)
Leakage current	0.1 mA max.			
ON delay	0.5 ms max.			
OFF delay	1.5 ms max.			
Number of circuits per common	8 outputs/common		16 outputs/common	
Communications power supply current consumption	5 mA		10 mA	
Weight	80 g max.		120 g max.	

## CompoNet Bit Slave Units with Connectors

# CRT1B-□D02S(-1)/□D02SP(-1)/ID04SP(-1)

### Simple and Intelligent Bit Slaves with Industry-standard e-CON connectors.

Slave Units capable of 2- and 4-point bit-level distribution. The I/O power supply is supplied from the communications power in the previously connected flat cable, and has a short-circuit detection function for protection.

IP54 dust- and splash-proof models also available.

- Industry-standard e-CON connectors
- Short-circuit protection safeguards the network from I/O short circuits.
- Simple communications connections with flat cable and connectors.
- Models with 2 or 4 points eliminate the need for unnecessary I/O points.
- IEC 60529 protection enables bit-level distributed installation without control boxes (IP54 Units).
- Dust- and splash-proof models can be used in environments where protection is necessary (IP54 Units).
- Bit-level distribution to support essentially any application.



### Ordering Information

Name	Specifications			Communications Cables			Model	Standards
				VCTF 2-conductor cable	Standard Flat Cable I	Sheathed Flat Cable II		
IP20	Inputs	2 inputs	NPN	Yes	No		CRT1B-ID02S	CE, UC1 (pending)
			PNP				CRT1B-ID02S-1	
	Outputs	2 outputs	NPN				CRT1B-OD02S	
			PNP				CRT1B-OD02S-1	
IP54	Inputs	2 inputs	NPN	No	Yes		CRT1B-ID02SP	
			PNP				CRT1B-ID02SP-1	
	Outputs	2 outputs	NPN				CRT1B-OD02SP	
			PNP				CRT1B-OD02SP-1	
	Inputs	4 DC inputs	NPN				CRT1B-ID04SP	
			PNP				CRT1B-ID04SP-1	

### International Standards

- The standards indicated in the "Standards" column are those current for UL, CSA, cULus, NK, and Lloyd standards and EC Directives as of the end of October 2007. The standards are abbreviated as follows; U: UL, U1: UL Class I Division 2 Products for Hazardous Locations, C: CSA, UC: cULus, UC1: cULus Class I Division 2 Products for Hazardous Locations, CU: cUL, N: NK, L: Lloyd, and CE: EC Directive.
- Ask your OMRON representative for the conditions under which the standards were met.

## Performance Specifications

Item	Specification
Communications power supply voltage	14 to 26.4 VDC
I/O power supply voltage	20.4 to 26.4 VDC (24 VDC -15%/+10%)
Noise immunity	Conforms to IEC 61000-4-4 2 kV (power line).
Vibration resistance	10 to 60 Hz with double-amplitude of 0.7 mm, 60 to 150 Hz and 50 m/s <sup>2</sup> in X, Y, and Z directions for 80 min each
Shock resistance	150 m/s <sup>2</sup> (3 times each in 6 directions on 3 axes)
Dielectric strength	500 VAC (between isolated circuits)
Insulation resistance	20 MΩ min. (between isolated circuits)
Ambient operating temperature	-10 to 55°C
Ambient operating humidity	25% to 85% (with no condensation)
Ambient operating atmosphere	No corrosive gases
Storage temperature	-25 to 65°C
Storage humidity	25% to 85% (with no condensation)
Installation	Secured with M4 screws

## Input Section Specifications

Item	Specification					
Model	CRT1B-ID02S	CRT1B-ID02S-1	CRT1B-ID02SP	CRT1B-ID02SP-1	CRT1B-ID04SP	CRT1B-ID04SP-1
I/O capacity	2 inputs				4 inputs	
Internal I/O common	NPN	PNP	NPN	PNP	NPN	PNP
ON voltage	10.5 VDC min. (between each input terminal and the V terminal)	10.5 VDC min. (between each input terminal and the G terminal)	10.5 VDC min. (between each input terminal and the V terminal)	10.5 VDC min. (between each input terminal and the G terminal)	10.5 VDC min. (between each input terminal and the V terminal)	10.5 VDC min. (between each input terminal and the G terminal)
OFF voltage	5 VDC max. (between each input terminal and the V terminal)	5 VDC max. (between each input terminal and the G terminal)	5 VDC max. (between each input terminal and the V terminal)	5 VDC max. (between each input terminal and the G terminal)	5 VDC max. (between each input terminal and the V terminal)	5 VDC max. (between each input terminal and the G terminal)
OFF current	1.0 mA max.					
Input current	3.0 mA max./input (at 10.5 VDC)					
Sensor power supply voltage	Communications power supply voltage + 0 V (max.) Communications power supply voltage - 1 V (min.)					
ON delay	1.5 ms max.					
OFF delay	1.5 ms max.					
Number of circuits per common	2 inputs/common				4 inputs/common	
Sensor power short-circuit detection	Detected.					
Isolation method	No isolation					
Input indicators	LEDs (yellow)					
Degree of protection	IEC standard IP20			IEC standard IP54		
Installation	Screw installation (M4)					
Power supply type	Network power supply					
Communications power supply current consumption (See note.)	65 mA max. for 24-VDC power supply voltage 80 mA max. for 14-VDC power supply voltage	45 mA max. for 24-VDC power supply voltage 65 mA max. for 14-VDC power supply voltage	65 mA max. for 24-VDC power supply voltage 80 mA max. for 14-VDC power supply voltage		85 mA max. for 24-VDC power supply voltage 90 mA max. for 14-VDC power supply voltage	
Weight	70 g max.			184 g max.		188 g

**Note:** The current consumption is for Bit Slave Unit communications current when all inputs are OFF, i.e., it does not include input device current consumption. The communications power supply is also used for the I/O power supply for sensors. Be sure to consider the sensor current consumption and the number of sensors connected in addition to the communications power.

The power supply current consumption is expressed by the following formula.

Communications power supply current consumption = Bit Slave Unit communications current consumption + (Bit Slave Unit input current x number of inputs used) + (sensor current consumption x number of sensors used)

## Output Section Specifications

Item	Specification			
Model	CRT1B-OD02S	CRT1B-OD02S-1	CRT1B-OD02SP	CRT1B-OD02SP-1
I/O capacity	2 outputs			
Internal I/O common	NPN	PNP	NPN	PNP
Rated output current	0.2 A/output			
Load power supply voltage	Communications power supply voltage + 0 V (max.) Communications power supply voltage – 1.2 V (min.)			
Residual voltage	1.2 V max. (0.2 A DC, between each output terminal and the V terminal)	1.2 V max. (0.2 A DC, between each output terminal and the G terminal)	1.2 V max. (0.2 A DC, between each output terminal and the V terminal)	1.2 V max. (0.2 A DC, between each output terminal and the G terminal)
Leakage current	0.1 mA max.			
ON delay	0.5 ms max.			
OFF delay	1.5 ms max.			
Number of circuits per common	2 outputs/common			
External load power short-circuit detection	Detected.			
Isolation method	No isolation			
Output indicators	LEDs (yellow)			
Degree of protection	IEC standard IP20		IEC standard IP54	
Installation	Screw installation (M4)			
Power supply type	Network power supply			
Communications power supply current consumption (See note.)	55 mA max. for 24-VDC power supply voltage 75 mA max. for 14-VDC power supply voltage	55 mA max. for 24-VDC power supply voltage 70 mA max. for 14-VDC power supply voltage	50 mA max. for 24-VDC power supply voltage 75 mA max. for 14-VDC power supply voltage	
Weight	59 g max.		169 g max.	

**Note:** The current consumption is for Bit Slave Unit communications current when all outputs are OFF, i.e., it does not include output device load current consumption. The communications power supply is also used for the I/O power supply for actuators. Be sure to consider the actuator load current consumption and the number of actuators connected in addition to the communications power.  
The power supply current consumption is expressed by the following formula.  
Communications power supply current consumption = Bit Slave Unit communications current consumption + (Bit Slave Unit input current x number of inputs used) + (actuator load current x number of actuators used)

# CompoNet Bit Slave Units with Clamp Terminal Blocks CRT1B-MD04SLP(-1)

## Simple and Intelligent IP54 Bit Slave Units That Resist Dust and Splashing

Screw-less dust- and splash-proof IP54 Bit Slaves for bit-level distribution.

The I/O power supply is supplied from the communications power in the previously connected flat cable, and has a short-circuit detection function for protection.

- IEC 60529 protection enables bit-level distributed installation without control boxes.
- Screw-less models makes wiring as easy as a single push.
- Short-circuit protection safeguards the network from I/O short circuits.
- Simple communications connections with flat cable and connectors.
- Models with 2 or 4 points eliminate the need for unnecessary I/O points.
- Dust- and splash-proof models can be used in environments where protection is necessary.
- Bit-level distribution to support essentially any application.



### Ordering Information

Name	Specifications			Communications Cables			Model	Standards
				VCTF 2-conductor cable	Standard Flat Cable I	Sheathed Flat Cable II		
IP54	Inputs/outputs	2 inputs and 2 outputs	NPN	No	No	Yes	CRT1B-MD04SLP	CE, UC1 (pending)
			PNP				CRT1B-MD04SLP-1	

### International Standards

- The standards indicated in the “Standards” column are those current for UL, CSA, cULus, NK, and Lloyd standards and EC Directives as of the end of October 2007. The standards are abbreviated as follows; U: UL, U1: UL Class I Division 2 Products for Hazardous Locations, C: CSA, UC: cULus, UC1: cULus Class I Division 2 Products for Hazardous Locations, CU: cUL, N: NK, L: Lloyd, and CE: EC Directive.
- Ask your OMRON representative for the conditions under which the standards were met.

## Performance Specifications

Item	Specification
Communications power supply voltage	14 to 26.4 VDC
I/O power supply voltage	20.4 to 26.4 VDC (24 VDC -15%/+10%)
Noise immunity	Conforms to IEC 61000-4-4 2 kV (power line).
Vibration resistance	10 to 60 Hz with double-amplitude of 0.7 mm, 60 to 150 Hz and 50 m/s <sup>2</sup> in X, Y, and Z directions for 80 min each
Shock resistance	150 m/s <sup>2</sup> (3 times each in 6 directions on 3 axes)
Dielectric strength	500 VAC (between isolated circuits)
Insulation resistance	20 MΩ min. (between isolated circuits)
Ambient operating temperature	-10 to 55°C
Ambient operating humidity	25% to 85% (with no condensation)
Ambient operating atmosphere	No corrosive gases
Storage temperature	-25 to 65°C
Storage humidity	25% to 85% (with no condensation)
Installation	Secured with M4 screws

## Input Section Specifications

Item	Specification	
Model	CRT1B-MD04SLP	CRT1B-MD04SLP-1
I/O capacity	2 inputs	
Internal I/O common line	NPN	PNP
ON voltage	10.5 VDC min. (between each input terminal and the V terminal)	10.5 VDC min. (between each input terminal and the G terminal)
OFF voltage	5 VDC max. (between each input terminal and the V terminal)	5 VDC max. (between each input terminal and the G terminal)
OFF current	1 mA max.	
Input current	3.0 mA max./input (at 10.5 VDC)	
Sensor power supply voltage	Communications power supply voltage + 0 V (max.) Communications power supply voltage - 1 V (min.)	
ON delay	1.5 ms max.	
OFF delay	1.5 ms max.	
Number of circuits per common	2 inputs/common	
Sensor power short-circuit detection	Detected.	
Isolation method	No isolation	
Input indicators	LEDs (yellow)	
Degree of protection	IEC standard IP54	
Installation	Screw installation (M4)	
Power supply type	Network power supply	
Communications power supply current consumption (See note.)	80 mA max. for 24-VDC power supply voltage 90 mA max. for 14-VDC power supply voltage	75 mA max. for 24-VDC power supply voltage 85 mA max. for 14-VDC power supply voltage
Weight	191 g max.	

**Note:** The current consumption is for Bit Slave Unit communications current when all inputs and outputs are OFF, i.e., it does not include input device current consumption or output load current consumption. The communications power supply is also used for the I/O power supply for sensors and actuators. Be sure to consider the sensor and actuator current consumption and the number of sensors and actuators connected.

The power supply current consumption is expressed by the following formula.

Communications power supply current consumption = Bit Slave Unit communications current consumption + (Bit Slave Unit input current x number of inputs used) + (sensor current consumption x number of sensors used) + (actual load current x number of actuators used)



## Output Section Specifications

Item	Specification	
Model	CRT1B-MD04SLP	CRT1B-MD04SLP-1
I/O capacity	2 outputs	
Internal I/O common	NPN	PNP
Rated output current	0.2 A/output	
Load power supply voltage	Communications power supply voltage + 0 V (max.) Communications power supply voltage – 1.2 V (min.)	
Residual voltage	1.2 V max. (0.2 A DC, between each output terminal and the G terminal)	1.2 V max. (0.2 A DC, between each output terminal and the V terminal)
Leakage current	0.1 mA max.	
ON delay	0.5 ms max.	
OFF delay	1.5 ms max.	
Number of circuits per common	2 outputs/common	
External load power short-circuit detection	Detected.	
Isolation method	No isolation	
Input indicators	LEDs (yellow)	

# CompoNet Repeater Unit CRS1-RPT01

## Simple and Intelligent Repeater Units Extend the Network

Repeater Units can make CompoNet Networks easier to wire, and extend cable length.

When Repeater Units are connected in series from the Master Unit, up to two extra segment layers can be created (i.e., up to 2 Repeater Units are allowed between a Slave Unit and the Master Unit).

- Expand the network to up to 1,500 m using two segment layers of Repeater Units (baud rate: 93.75 kbits/s).
- Avoid total system breakdown caused by errors in lower-level Units.
- Repeater Units allow a different cable types to be used in the same network.
- Implement various network layouts by branching lines or extending the trunk line.
- Display a network configuration list or identify error locations by using the setting and monitoring software for CompoNet.
- Monitor the power supply for the entire network with communications power supply monitoring function.



### Ordering Information

Name	Specifications	Communications Cables			Model	Standards
		VCTF 2-conductor cable	Standard Flat Cable I	Sheathed Flat Cable II		
Repeater Unit	A sub-trunk line can be connected downstream (for trunk-branch line configuration) or further branching is enabled downstream (for configurations with no wiring restrictions) in the same way as for a Master Unit. A Repeater Unit can be used to branch the trunk line and increase the number of connected Units, as well as to extend the length of the communications line.	Yes	Yes	Yes	CRS1-RPT01	CE, UC1 (pending)

### International Standards

- The standards indicated in the “Standards” column are those current for UL, CSA, cULus, NK, and Lloyd standards and EC Directives as of the end of October 2007. The standards are abbreviated as follows; U: UL, U1: UL Class I Division 2 Products for Hazardous Locations, C: CSA, UC: cULus, UC1: cULus Class I Division 2 Products for Hazardous Locations, CU: cUL, N: NK, L: Lloyd, and CE: EC Directive.
- Ask your OMRON representative for the conditions under which the standards were met.

## Specifications

Item	Specification
Model	CRS1-RPT01
Communications ports	Upstream port (port 1): Trunk line or sub-trunk line Downstream port (port 2): Sub-trunk line (Can be wired with the same communications specifications as the Master Unit.) Different types of communications cable can be connected to the upstream and downstream ports.
Maximum number of layers	Up to two extra segment layers can be created from the Master Unit.
Number of nodes per network (per Master Unit)	64 nodes
Number of nodes per trunk line or sub-trunk line	32 nodes (Including Slave Units)
Communications power supply connector	One downstream communications port power supply connector <b>Note:</b> Communications power for the Repeater Unit is supplied from the BS+ and BS- terminals on the upstream port communications connector (PORT1).
Communications power supply connector allowable current capacity	5 A max.
Noise immunity	Conforms to IEC 61000-4-4 2 kV (power line).
Vibration resistance	10 to 150 Hz with double-amplitude of 0.7 mm or 50 m/s <sup>2</sup>
Shock resistance	150 m/s <sup>2</sup>
Dielectric strength	500 VAC (between isolated circuits)
Insulation resistance	20 MΩ min. (between isolated circuits)
Ambient operating temperature	-10 to 55°C
Ambient operating humidity	25% to 85% (with no condensation)
Ambient operating atmosphere	No corrosive gases
Storage temperature	-25 to 65°C
Storage humidity	25% to 85% (with no condensation)
Installation	DIN Track or M4 screws
Weight	73 g
Communications power supply voltage	14 to 26.4 VDC
Communications power supply current consumption	95 mA max.

Sensor Communications Unit

# ZS-CRT

## A Communications Gateway that Connects Smart Sensors to Compo-Net.

High-Speed Smart Sensor measurement data collection at the PLC or PT.

- Start up simply by connecting the communications cable.
- Supports triggered measurements and acquisition of judgment results, and features control signal lines that do not require wiring.



### Ordering Information

Name	I/O classification	Allocated bits	Internal circuit power supply	I/O power supply voltage	Connected Controller model	Model	Standards
Sensor Communications Unit	Input and output	160 bits max.	Supplied along with communications power	24 VDC	ZS-LDC□□ ZS-MDC□□ ZS-HLDC□□ ZFV-CA□□ ZG-WDC□□	ZS-CRT	CE

### International Standards

- The standards indicated in the “Standards” column are those current for UL, CSA, cULus, NK, and Lloyd standards and EC Directives as of the end of October 2007. The standards are abbreviated as follows; U: UL, U1: UL Class I Division 2 Products for Hazardous Locations, C: CSA, UC: cULus, UC1: cULus Class I Division 2 Products for Hazardous Locations, CU: cUL, N: NK, L: Lloyd, and CE: EC Directive.
- Ask your OMRON representative for the conditions under which the standards were met.

### Performance Specifications

Item	Specification
Communications power supply voltage	14 to 26.4 VDC
Communications power supply current consumption	200 mA max.
Connected Controller models	ZS-LDC□□ (Ver. 2.300 or later), ZS-MDC□□ (Ver. 2.200 or later), ZS-HLDC□□ (Ver. 1.030 or later), ZFV-CA□□ (Ver. 1.300 or later), ZG-WDC□□ (Ver. 1.100 or later)
Functions	Constant monitoring function for measurement results, trigger measurement monitoring function, message communications function
Indicators	MS (green/red), NS (green/red), and USB (green/red)
Vibration resistance	10 to 150 Hz with double-amplitude of 0.7 mm or 50 m/s <sup>2</sup>
Shock resistance	150 m/s <sup>2</sup>
Dielectric strength	1,000 VAC 50/60 Hz for 1 min
Insulation resistance	30 MΩ min.
Ambient operating temperature	00 to 50°C
Ambient operating humidity	25% to 85% (with no condensation)
Storage temperature	-15 to 65°C (No icing or condensation)
Storage humidity	25% to 85% (with no condensation)
Installation	Mounted on 35-mm DIN Track
Degree of protection	IP20
Material	Case: ABS
Accessories	Instruction Manual, ferrite core
Weight	Approx. 130 g

---

# Appendix

---

CompoNet Network Configuration Elements .....	36
Communications and I/O Power Supply Wiring .....	37
Power Supplies .....	39

# CompoNet Network Configuration Elements

A CompoNet Network is a remote I/O system that consists of the following elements.

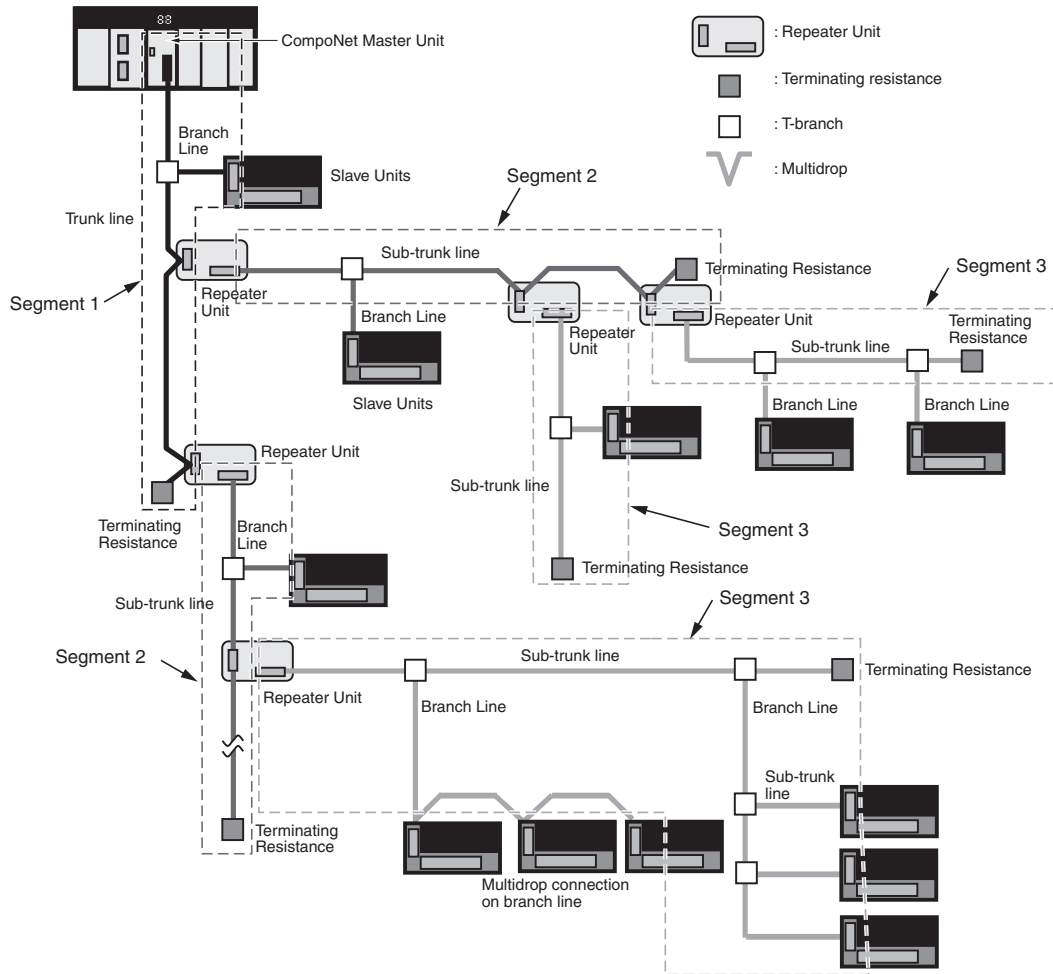

## Segment

### ■ Segment layers

When Repeater Units are used, the CompoNet Network is divided into segments by the Repeater Units. Each segment is connected to the network, but is isolated electrically.

Three layers of these isolated segments can be configured, called segments 1, 2, and 3, counted in order from the Master Unit.

Repeater Units can be used to add a maximum of two extra segment layers.

Including Repeater Units connected using multidrop connections, a maximum of 64 Repeater Units can be connected in a single network (i.e., to a single Master Unit).

### ■ Number of Units Per Segment

A maximum of 32 Slave Units and Repeater Units can be connected in the same segment.

# Communications and I/O Power Supply Wiring

The following power supplies are required to operate the CompoNet Network.

- Communications power supply: Used for communications with individual Units and for internal circuit operations of Units.
- I/O power supply: Used for I/O operations for Units with external I/O.

The method for supplying communications power and I/O power depends on the types of cable and Slave Unit that are used. The differences are shown in the following table.

Power supply method	Cable types	Communications power supply	I/O power supply
Multi-power supply	Flat Cable	Supplied through the Communications Cable by supplying power to the Master Unit.	Supplied to individual Units separately from the communications power supply.
	Round Cable I	Supplied to Units individually	
Network power supply	Flat Cable	The communications power supply and the I/O power supply are provided together through Communications Cable.	
	Round Cable I	Cannot be used.	

## Connection Locations for Communications Power Supply

### ■ Flat Cable

Connect a 24-VDC power supply to the Master Unit's communications power supply connector (BS+ and BS-). This provides communications power to each Slave Unit and Repeater Unit connected by Flat Cable. Connect only one communications power supply for the trunk line. The cable between the communications power supply and the communications power supply connector must be no longer than 3 m.

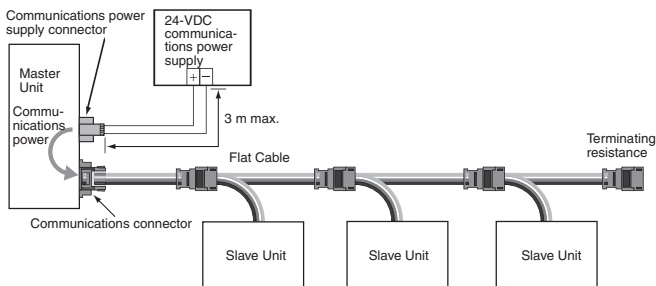

When Repeater Units are used, communications power to sub-trunk lines is supplied by the downstream port communications power supply connectors (BS+ and BS-) of the Repeater Units. The cable between the communications power supply and the communications power supply connector must be no longer than 3 m.

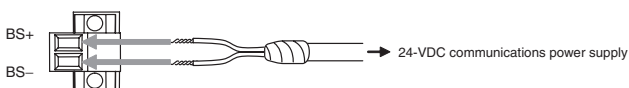
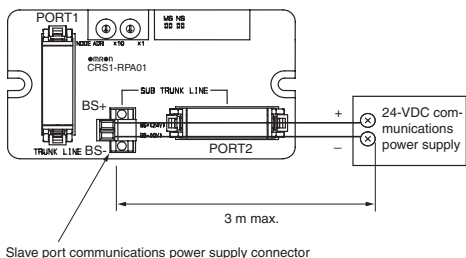

### ● Ferrules

The following ferrules are recommended for the communications power supply cable.

Model	Applicable wire size	Crimping tool	Manufacturer
A10, 5-10 WH	0.5 mm/AWG20	CRIMPFOX UD6 (product number 1204436) or the CRIMPFOX ZA3 Series	Phoenix Contact K.K.
H 0.5/16 orange	0.5 mm/AWG20	Crimper PZ 1.5 (Product number 900599)	Weidmuller Co. Ltd.

### ■ Round Cable

A 24-VDC power supply is connected individually to each Slave Unit. Power does not need to be supplied to the Master Unit.

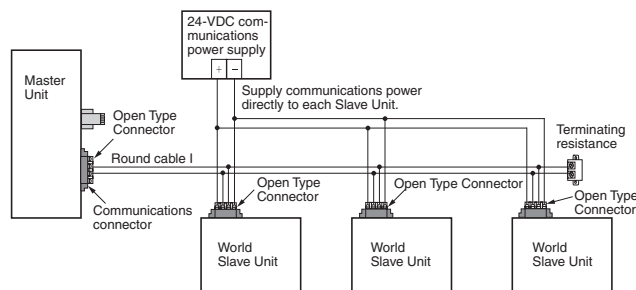

Before connecting the power supply, first connect a DCN4-TB4 Open Type Connector to the communications connector to convert it to a screw terminal block.

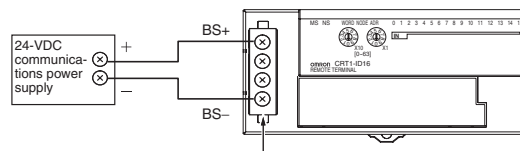

Connect an Open Type Connector here.

When using a Repeater Unit, supply power through the BS+ and BS- terminals of the Repeater Unit's PORT1 connector.

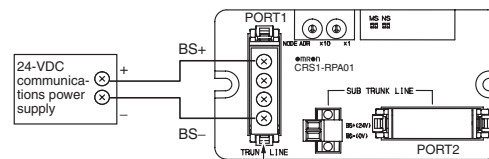

Connect an Open Type Connector here.

The following screwdriver is recommended for removing ferrules.

Model	Manufacturer
XW4Z-00C	OMRON Corporation

## Restrictions

The following restrictions apply when supplying communications power through Flat Cable.

- The communications power supply can be connected at only one location for the trunk line and one location each for the sub-trunk lines.
- Communications power to the trunk line can be supplied only through the communications power supply connector on the Master Unit. Communications power to a sub-trunk line can be supplied only through the slave port communications power supply connector on the Repeater Unit. Communications power cannot be supplied at any other location.

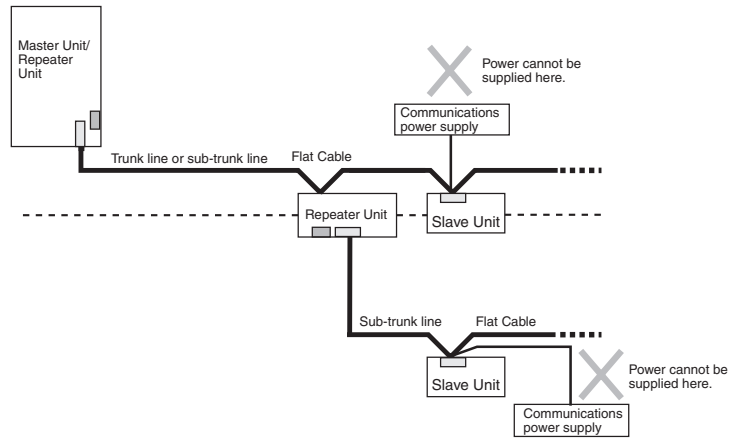
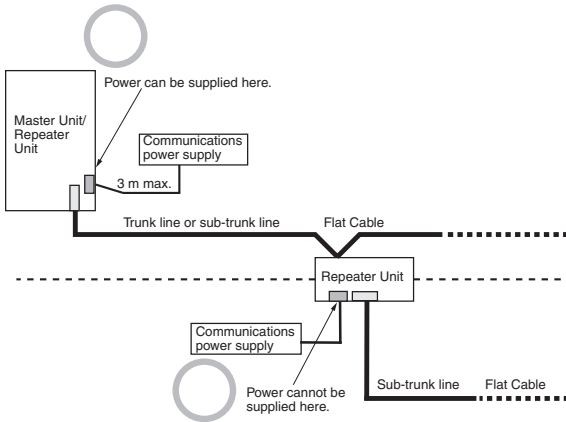

- Use separate power supplies for the Master Unit trunk line and for each sub-trunk line (i.e., for the trunk line on the Master side of the Repeater Unit and the sub-trunk line on the Slave side).

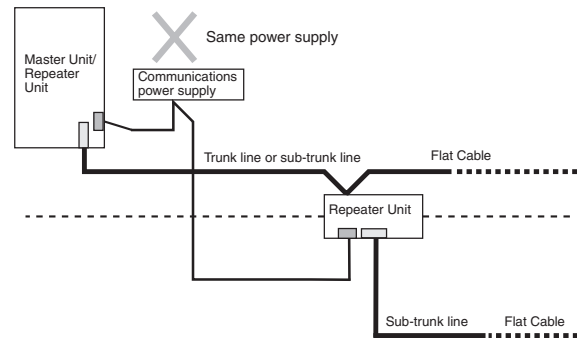
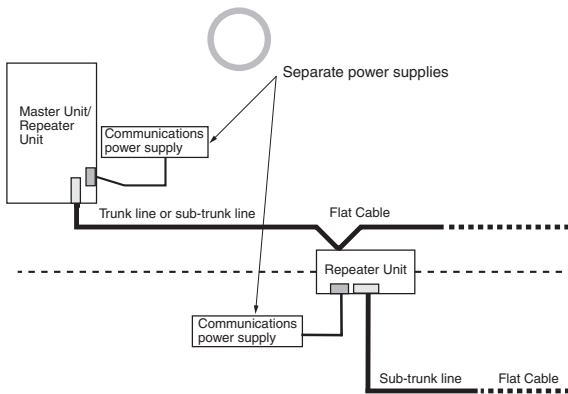

Transmission quality will not be maintained and communications errors may occur if this restriction is not observed.



**Power Supplies**

**S8VS** Switch Mode Power Supply (15/30/60/90/120/180/240-W Models)

**15/30-W Models**

**Compact, Thin Power Supplies That Mount Just About Anywhere to Contribute to Control Panel Downsizing**

- Compact, thin size: 22.5 × 85 × 96.5 mm (W × H × D).
- Three mounting directions (standard, horizontal, facing horizontal).
- Mounting directly to the panel is possible.
- Safety standards:  
UL 508/60950-1/1604, cUL: CSA C22.2 No. 14/60950-1/213,  
EN 50178 (= VDE0160), EN 60950-1 (= VDE 0805 Teil 1).
- Mount to DIN Rail.
- Warranty Period: 3 years.
- Lead-free solder. (Eco-label-certified Product)



**(60-W, 90-W, 120-W, 180-W, and 240-W Models)**

**Models with Accumulated Operating Time Function and Maintenance Forecast Monitor Function Added to the Series**

- Compact size: 40 × 95 × 108.3 mm (W × H × D) (60-W Models).
- Display shows status with 3-digit, 7-segment LED display.
- Safety standards:  
UL 508/60950, CSA C22.2 No. 14/60950-1/213, EN 50178 (= VDE 0160), EN 60950-1 (= VDE 0805 Teil 1).
- Mount to DIN Rail.
- Warranty Period: 3 years.
- Lead-free soldering. (Eco-label-certified Product)



**S8VM** Switch Mode Power Supply (15/30/50/100/150/300/600/1,500-W Models)

**Power Supply Featuring OMRON's Unique, New Undervoltage Compact Body Contributing to Machine Downsizing**

- New undervoltage alarm function assists in determining causes of errors (S8VM-□□□24A□/P□ only).
- Power failure alarm function provides notification of output voltage errors (300-, 600-, and 1,500-W models only).
- Broad range of possibilities with 8 capacities and 29 models to choose from.
- RoHS-compliant including lead-free construction.
- Safety standards: UL508/60950-1/1604, CSA C22.2 No. 14/No. 60950-1/No. 213, EN50178, EN60950-1 (The 300-, 600-, and 1,500-W models will not conform to safety standards if the customer replaces the fan.)
- Harmonic current emissions: Conforms to EN61000-3-2 (except for 15- and 30-W models).
- New, attentive design prevents screws from falling out of terminal block (except for output terminals of 300-, 600-, and 1,500-W models).
- Finger protection prevents electric shock.
- Mount to DIN Rail.
- Warranty Period: 5 years. (The fan is not covered.)



MEMO

A large grid of dashed lines for writing, consisting of 20 columns and 20 rows of squares.

---

# Ordering Information

---

CompoNet Master Units .....	42
CompoNet Slave Units .....	42
■ Word Slave Units .....	42
■ Bit Slave Units .....	43
■ Repeater Unit .....	43
■ Sensor Communications Unit .....	43
Peripheral Devices .....	44
■ Communications Cables .....	44
■ Connectors .....	44
■ Terminating Resistance .....	44
■ Special Tools .....	44
■ Connectors .....	45
■ Terminating Resistance .....	45
■ Special Tools .....	45

---

## ● International Standards

- The standards indicated in the “Standards” column are those current for UL, CSA, cULus, NK, and Lloyd standards and EC Directives as of the end of October 2007. The standards are abbreviated as follows; U: UL, U1: UL Class 1 Division 2 Products for Hazardous Locations, C: CSA, UC: cULus, UC1: cULus Class 1 Division 2 Products for Hazardous Locations, CU: cUL, N: NK, L: Lloyd, and CE: EC Directive.
- Ask your OMRON representative for the conditions under which the standards were met.

## ● EC Directives

The EC Directives applicable to PLCs include the EMC Directives and the Low Voltage Directive. OMRON complies with these directives described below.

## ● EMC Directives

### Applicable Standards

EMI : EN61131-2  
EN61000-6-4  
EMS: EN61131-2  
EN61000-6-2

PLCs are electrical devices that are incorporated in machines and manufacturing installations. OMRON PLCs conform to the related EMC standards so that the devices and machines into which they are built can more easily conform to EMC standards. The actual PLCs have been checked for conformity to EMC standards. Whether these standards are satisfied for the actual system, however, must be checked by the customer.

EMC-related performance will vary depending on the configuration, wiring, and other conditions of the equipment or control panel in which the PLC is installed. The customer must, therefore, perform final checks to confirm that the overall machine or device conforms to EMC standards.

Note: The applicable EMS standards depend on the product.



## ● Low Voltage Directive

### Applicable Standard:EN61131-2

Devices that operate at voltages from 50 to 1,000 VAC or 75 to 150 VDC must satisfy the appropriate safety requirements. With PLCs, this applies to Power Supply Units and I/O Units that operate in these voltage ranges.

These Units have been designed to conform to EN61131-2, which is the applicable standard for PLCs.



## CompoNet Master Units

Name	Appearance	Specifications		Number of unit numbers allocated	Power consumption (A)			Model	Standards
		Type of communications	Maximum number of I/O points per Master Unit		5-V system	24-V system	26-V system		
CS1 Special I/O Unit		<ul style="list-style-type: none"> <li>Remote I/O communications</li> <li>Message communications</li> </ul>	Word Slave Units: 1,024 inputs and 1,024 outputs (2,048 I/O points total) Bit Slave Units: 256 inputs and 256 outputs (512 I/O points total)	1, 2, 4, or 8	0.4	/	---	CS1W-CRM21	CE, U1, UC1 (pending)
CJ1 Special I/O Unit		<ul style="list-style-type: none"> <li>Remote I/O communications</li> <li>Message communications</li> </ul>	Word Slave Units: 1,024 inputs and 1,024 outputs (2,048 I/O points total) Bit Slave Units: 256 inputs and 256 outputs (512 I/O points total)	1, 2, 4, or 8	0.4	---	/	CJ1W-CRM21	CE, U1, UC1 (pending)

## CompoNet Slave Units

### Word Slave Units

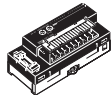
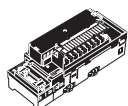
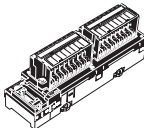
#### Digital I/O Slave Units

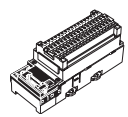
Name	Appearance	Specifications			Communications Cables			Model	Standards
					VCTF 2-conductor cable	Standard Flat Cable I	Sheathed Flat Cable II		
Two-tier Screw Terminal Block		Inputs	16 inputs	NPN	Yes	Yes	Yes	CRT1-ID16	CE, UC1 (pending)
				PNP				CRT1-ID16-1	
		Outputs	16 outputs	NPN				CRT1-OD16	
				PNP				CRT1-OD16-1	
Screw Terminal Block with Relay Outputs		Outputs	16 outputs	Contacts	Yes	Yes	Yes	CRT1-ROS16 <b>NEW</b>	CE, UC1 (pending)
Three-tier Screw Terminal Block		Inputs	16 inputs	NPN	Yes	Yes	Yes	CRT1-ID16TA <b>NEW</b>	CE, UC1 (pending)
				PNP				CRT1-ID16TA-1 <b>NEW</b>	
		Outputs	16 outputs	NPN				CRT1-OD16TA <b>NEW</b>	
				PNP				CRT1-OD16TA-1 <b>NEW</b>	
		Inputs/outputs	8 inputs and 8 outputs	NPN				CRT1-MD16TA <b>NEW</b>	
				PNP				CRT1-MD16TA-1 <b>NEW</b>	
Digital I/O Slave Units with Connectors		Inputs	16 inputs	NPN	Yes	Yes	Yes	CRT1-ID16S <b>NEW</b>	CE, UC1 (pending)
				PNP				CRT1-ID16S-1 <b>NEW</b>	
		Outputs	16 outputs	NPN				CRT1-OD16S <b>NEW</b>	
				PNP				CRT1-OD16S-1 <b>NEW</b>	
		Inputs/outputs	8 inputs and 8 outputs	NPN				CRT1-MD16S <b>NEW</b>	
				PNP				CRT1-MD16S-1 <b>NEW</b>	
CompoNet Digital I/O Slaves with Clamp Terminals		Inputs	16 inputs	NPN	Yes	Yes	Yes	CRT1-ID16SL <b>NEW</b>	CE, UC1 (pending)
				PNP				CRT1-ID16SL-1 <b>NEW</b>	
		Outputs	16 outputs	NPN				CRT1-OD16SL <b>NEW</b>	
				PNP				CRT1-OD16SL-1 <b>NEW</b>	

#### Analog I/O Slave Units

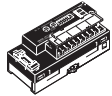
Name	Appearance	Specifications		Communications Cables			Model	Standards
				VCTF 2-conductor cable	Standard Flat Cable I	Sheathed Flat Cable II		
Analog I/O Slave Units		Analog inputs	4 inputs	Yes	Yes	Yes	CRT1-AD04	CE, UC1 (pending)
		Analog outputs	2 outputs				CRT1-DA02	

● Expansion Units

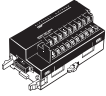
Name	Appearance	Specifications				Model	Standards
		Inputs	Outputs	NPN	PNP		
Expansion Units		Inputs	8 inputs	NPN	One Expansion Unit can be mounted to each Digital I/O Slave with a 2-tier Screw Terminal Block.	XWT-ID08	CE, UC1, N
				PNP		XWT-ID08-1	
		Outputs	8 outputs	NPN		XWT-OD08	
				PNP		XWT-OD08-1	
		Inputs	16 inputs	NPN		XWT-ID16	
				PNP		XWT-ID16-1	
		Outputs	16 outputs	NPN		XWT-OD16	
				PNP		XWT-OD16-1	

■ Bit Slave Units

● Units with Connectors

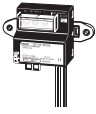
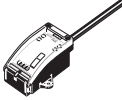
Name	Appearance	Specifications			Communications Cables			Model	Standards
					VCTF 2-conductor cable	Standard Flat Cable I	Sheathed Flat Cable II		
IP20		Inputs	2 inputs	NPN	No	Yes	No	CRT1B-ID02S	CE, UC1 (pending)
				PNP				CRT1B-ID02S-1	
		Outputs	2 outputs	NPN				CRT1B-OD02S	
				PNP				CRT1B-OD02S-1	
IP54		Inputs	2 inputs	NPN	No	No	Yes	CRT1B-ID02SP	
				PNP				CRT1B-ID02SP-1	
		Outputs	2 outputs	NPN				CRT1B-OD02SP	
				PNP				CRT1B-OD02SP-1	
		Inputs	4 DC inputs	NPN				CRT1B-ID04SP	
				PNP				CRT1B-ID04SP-1	

● Units with Clamp Terminals

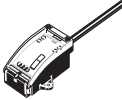
Name	Appearance	Specifications			Communications Cables			Model	Standards
					VCTF 2-conductor cable	Standard Flat Cable I	Sheathed Flat Cable II		
IP54		Inputs/outputs	2 inputs and 2 outputs	NPN	No	No	Yes	CRT1B-MD04SLP	CE, UC1 (pending)
				PNP				CRT1B-MD04SLP-1	

■ Repeater Unit

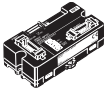

Name	Appearance	Specifications			Communications Cables			Model	Standards
					VCTF 2-conductor cable	Standard Flat Cable I	Sheathed Flat Cable II		
Repeater Unit		A sub-trunk line can be connected downstream (for trunk-branch line configuration) or further branching is enabled downstream (for configurations with no wiring restrictions) in the same way as for a Master Unit. A Repeater Unit can be used to branch the trunk line and increase the number of connected Units, as well as to extend the length of the communications line.			Yes	Yes	Yes	CRS1-RPT01	CE, UC1 (pending)

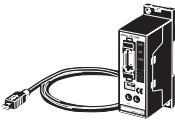
■ Sensor Communications Unit

Name	Appearance	I/O classification	Allocated bits	Internal circuit power supply	I/O Power supply voltage	Connected Controller model	Model	Standards
Sensor Communications Unit		Input and output	160 bits max.	Supplied along with communications power	24 VDC	ZS-LDC□□ ZS-MDC□□ ZS-HLDC□□ ZFV-CA□□ ZG-WDC□□	ZS-CRT	CE

## Peripheral Devices



### ■ Communications Cables

Name	Appearance	Specification	Model	Standards
Standard Flat Cable I		4-conductor flat cable (UL2555) Length: 100 m Conductor diameters: 0.75 mm <sup>2</sup> × 2, 0.5 mm <sup>2</sup> × 2	DCA4-4F10	---
Sheathed Flat Cable II		Sheathed 4-conductor flat cable (UL compliant) Length: 100 m Conductor diameters: 0.75 mm <sup>2</sup> × 2, 0.5 mm <sup>2</sup> × 2	DCA5-4F10	---

**Note:** Also can be used with general-purpose round cable I (VCTF 2-conductor cable).

### For Standard Flat Cable I

#### ■ Connectors

Name	Appearance	Application	Model	Standards
Flat Connector Socket		Use this Connector in a set with a DCN4-BR4 Flat Connector Plug for the following applications. <ul style="list-style-type: none"> <li>• Extending the trunk line or a sub-trunk line</li> <li>• T-branching from the trunk line or a sub-trunk line</li> <li>• T-branching a sub-branch line from a branch line</li> </ul>	DCN4-TR4	UC (pending)
Flat Connector Plug		Use this Connector independently for the following applications. <ul style="list-style-type: none"> <li>• Used when connecting a DCN4-TM4 Terminating Resistor to the end of the trunk line or a sub-trunk line.</li> </ul>		
Flat Connector Plug		Use this Connector in a set with a DCN4-TR4 Flat Connector Socket for the following applications. <ul style="list-style-type: none"> <li>• Extending the trunk line or a sub-trunk line</li> <li>• T-branching from the trunk line or a sub-trunk line</li> <li>• T-branching a sub-branch line from a branch line</li> </ul>	DCN4-BR4	
Multidrop Connector		Use this Connector independently for the following applications. <ul style="list-style-type: none"> <li>• Connecting Communications Cable to a Unit</li> <li>• Connecting Communications Cable to a DCN4-MD4 Multidrop Connector (when a multidrop connection is used)</li> </ul>	DCN4-MD4	
Multidrop Connector		Use Multidrop Connectors for multi-drop wiring of Slave Units or Repeater Units to trunk lines, sub-trunk lines, or branch lines.		

**Note:** The minimum quantity packaged is 10 Connectors. Order the Connectors in multiples of 10.

#### ■ Terminating Resistance

Name	Appearance	Application	Model	Standards
Terminating Resistance		This is a Connector-type Terminating Resistor for Flat Cable I. It is connected to a DCN4-TR4 Flat Connector Socket at the end of a trunk line or sub-trunk line.	DCN4-TM4	UC (pending)

**Note:** The minimum quantity packaged is 10 Connectors. Order the Connectors in multiples of 10.

#### ■ Special Tools

Name	Appearance	Application	Model	Standards
Special Tools		Crimping Tool for DCN4-TR4 Flat Connector Socket or DCN4-BR4 Flat Connector Plug	DWT-A01	---

**For Sheathed Flat Cable II**

**■ Connectors**

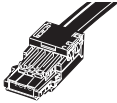
Name	Appearance	Application	Model	Standards
Flat Connector Socket		Use this Connector in a set with a DCN5-BR4 Flat Connector Plug for the following applications. <ul style="list-style-type: none"> <li>• Extending the trunk line or a sub-trunk line</li> <li>• T-branching from the trunk line or a sub-trunk line</li> <li>• T-branching a sub-branch line from a branch line</li> </ul> Use this Connector independently for the following applications. <ul style="list-style-type: none"> <li>• Used when connecting a DCN5-TM4 Terminating Resistor to the end of the trunk line or a sub-trunk line.</li> </ul>	DCN5-TR4	UC (pending)
Flat Connector Plug		Use this Connector in a set with a DCN5-TR4 Flat Connector Socket for the following applications. <ul style="list-style-type: none"> <li>• Extending the trunk line or a sub-trunk line</li> <li>• T-branching from the trunk line or a sub-trunk line</li> <li>• T-branching a sub-branch line from a branch line</li> </ul> Use this Connector independently for the following applications. <ul style="list-style-type: none"> <li>• Connecting Communications Cable to a Unit</li> </ul>	DCN5-BR4	

**Note:** The minimum quantity packaged is 10 Connectors. Order the Connectors in multiples of 10.

**■ Terminating Resistance**



Name	Appearance	Application	Model	Standards
Terminating Resistance		This is a Connector-type Terminating Resistor for Flat Cable II. It is connected to a DCN5-TR4 Flat Connector Socket at the end of a trunk line or sub-trunk line.	DCN5-TM4	UC (pending)

**Note:** The minimum quantity packaged is 10 Connectors. Order the Connectors in multiples of 10.

**■ Special Tools**

Name	Appearance	Application	Model	Standards
Special Tools		Crimping Tool for DCN5-TR4 Flat Connector Socket or DCN5-BR4 Flat Connector Plug	DWT-A02	---

**When Using VCTF 2-conductor Cable I**

Name	Appearance	Application	Model	Standards
Open Type Connector (for connecting Units)		Converts the Unit's communications connector into a screw terminal block to enable connecting round cable to a Slave Unit or Repeater Unit.	DCN4-TB4	UC (pending)
Terminating Resistor		This is a Terminal Block-type Terminating Resistor for round cable. It is connected to the end of a trunk line or sub-trunk line round cable.	DRS1-T	UC

**Note:** The minimum quantity packaged is 10 Connectors. Order the Connectors in multiples of 10.

**Related Manuals****Manuals**

<b>Cat. No.</b>	<b>Name</b>	<b>Contents</b>
<b>W457</b>	CompoNet Slave Units and Repeater Unit Operation Manual	Contains information on the specifications of CompoNet Slave Units and Repeater Units.
<b>W456</b>	CJ1W-CRM21/CJ1W-CRM21 CompoNet Master Units Operation Manual	Contains general information on CompoNet networks, information on communications specifications and wiring methods common to communications networks, and information on CS/CJ-series Master Units.
<b>W342</b>	SYSMAC CS/CJ/CP Series SYSMAC One NSJ Series Communications Commands Reference Manual	Contains information on communications commands for CS/CJ-series Master Units.



## Read and Understand this Catalog

Please read and understand this catalog before purchasing the product. Please consult your OMRON representative if you have any questions or comments.

## Warranty and Limitations of Liability

### WARRANTY

OMRON's exclusive warranty is that the products are free from defects in materials and workmanship for a period of one year (or other period if specified) from date of sale by OMRON.

OMRON MAKES NO WARRANTY OR REPRESENTATION, EXPRESS OR IMPLIED, REGARDING NON-INFRINGEMENT, MERCHANTABILITY, OR FITNESS FOR PARTICULAR PURPOSE OF THE PRODUCTS. ANY BUYER OR USER ACKNOWLEDGES THAT THE BUYER OR USER ALONE HAS DETERMINED THAT THE PRODUCTS WILL SUITABLY MEET THE REQUIREMENTS OF THEIR INTENDED USE. OMRON DISCLAIMS ALL OTHER WARRANTIES, EXPRESS OR IMPLIED.

### LIMITATIONS OF LIABILITY

OMRON SHALL NOT BE RESPONSIBLE FOR SPECIAL, INDIRECT, OR CONSEQUENTIAL DAMAGES, LOSS OF PROFITS OR COMMERCIAL LOSS IN ANY WAY CONNECTED WITH THE PRODUCTS, WHETHER SUCH CLAIM IS BASED ON CONTRACT, WARRANTY, NEGLIGENCE, OR STRICT LIABILITY.

In no event shall the responsibility of OMRON for any act exceed the individual price of the product on which liability is asserted.

IN NO EVENT SHALL OMRON BE RESPONSIBLE FOR WARRANTY, REPAIR, OR OTHER CLAIMS REGARDING THE PRODUCTS UNLESS OMRON'S ANALYSIS CONFIRMS THAT THE PRODUCTS WERE PROPERLY HANDLED, STORED, INSTALLED, AND MAINTAINED AND NOT SUBJECT TO CONTAMINATION, ABUSE, MISUSE, OR INAPPROPRIATE MODIFICATION OR REPAIR.

## Application Considerations

### SUITABILITY FOR USE

OMRON shall not be responsible for conformity with any standards, codes, or regulations that apply to the combination of the product in the customer's application or use of the product.

Take all necessary steps to determine the suitability of the product for the systems, machines, and equipment with which it will be used.

Know and observe all prohibitions of use applicable to this product.

NEVER USE THE PRODUCT FOR AN APPLICATION INVOLVING SERIOUS RISK TO LIFE OR PROPERTY WITHOUT ENSURING THAT THE SYSTEM AS A WHOLE HAS BEEN DESIGNED TO ADDRESS THE RISKS, AND THAT THE OMRON PRODUCT IS PROPERLY RATED AND INSTALLED FOR THE INTENDED USE WITHIN THE OVERALL EQUIPMENT OR SYSTEM.

### PROGRAMMABLE PRODUCTS

OMRON shall not be responsible for the user's programming of a programmable product, or any consequence thereof.

## Disclaimers

### CHANGE IN SPECIFICATIONS

Product specifications and accessories may be changed at any time based on improvements and other reasons. Consult with your OMRON representative at any time to confirm actual specifications of purchased product.

### DIMENSIONS AND WEIGHTS

Dimensions and weights are nominal and are not to be used for manufacturing purposes, even when tolerances are shown.

### PERFORMANCE DATA

Performance data given in this catalog is provided as a guide for the user in determining suitability and does not constitute a warranty. It may represent the result of OMRON's test conditions, and the users must correlate it to actual application requirements. Actual performance is subject to the OMRON Warranty and Limitations of Liability.

This catalog mainly provides information that is necessary for selecting suitable models, and does not contain precautions for correct use. Always read the precautions and other required information provided in product operation manuals before using the product.

- The application examples provided in this catalog are for reference only. Check functions and safety of the equipment before use.
- Never use the products for any application requiring special safety requirements, such as nuclear energy control systems, railroad systems, aviation systems, medical equipment, amusement machines, vehicles, safety equipment, or other application involving serious risk to life or property, without ensuring that the system as a whole has been designed to address the risks, and that the OMRON products are properly rated and installed for the intended use within the overall equipment or system.

**Note: Do not use this document to operate the Unit.**

Printed on 100%  
Recycled Paper



**OMRON Corporation**  
**Industrial Automation Company**  
**Control Devices Division H.Q.**  
**Network Devices Department**

Shiokoji Horikawa, Shimogyo-ku,  
Kyoto, 600-8530 Japan  
Tel: (81) 75-344-7116/Fax: (81) 75-344-7149

2-2-1 Nishikusatsu, Kusatsu-shi,  
Shiga, 525-0035 Japan  
Tel: (81)77-565-5219/Fax: (81)77-565-5569

**Regional Headquarters**

**OMRON EUROPE B.V.**  
Wegalaan 67-69, NL-2132 JD Hoofddorp  
The Netherlands  
Tel: (31)2356-81-300/Fax: (31)2356-81-388

**OMRON ELECTRONICS LLC**  
One Commerce Drive Schaumburg,  
IL 60173-5302 U.S.A.  
Tel: (1) 847-843-7900/Fax: (1) 847-843-7787

**OMRON ASIA PACIFIC PTE. LTD.**  
No. 438A Alexandra Road # 05-05/08 (Lobby 2),  
Alexandra Technopark, Singapore 119967  
Tel: (65) 6835-3011/Fax: (65) 6835-2711

**OMRON (CHINA) CO., LTD.**  
Room 2211, Bank of China Tower,  
200 Yin Cheng Zhong Road,  
Pu Dong New Area, Shanghai, 200120, China  
Tel: (86) 21-5037-2222/Fax: (86) 21-5037-2200

**Authorized Distributor:**

Note: Specifications subject to change without notice. Cat. No. P056-E1-03  
1207 (1006) (H)